



QUICK DESIGN GUIDE AND RULES OF THUMB

Span Tech • 101 Hilltopper Way • Glasgow, KY 42141 • (270) 651.9166
www.spantechconveyors.com

TABLE OF CONTENTS



CHAIN - GENERAL GUIDELINES | 3

Chain Materials | 4
Chain Structure | 5
Chain General | 6
Chain Dimensions | 8
Chain Guidelines | 11

CHAIN TYPES - SUPERTIGHT CHAIN | 17

25mm SuperTight Chain | 18
50mm SuperTight Chain | 23
50mm Pillow Top Chain | 25
Tube Top Rollers | 28

CHAIN TYPES - LEGACY CHAIN | 31

MultiSpan Chain | 32
MonoSpan Chain | 36
MaxiSpan Chain | 38

CHAIN TYPES - SPECIALTY | 41

Closed Top Chain | 42
MicroSpan Chain | 44
MlniLink Chain | 46
J-Trax Chain | 48

DIRECTIONAL SECTIONS | 50

Bed Sections | 51
Horizontal Curves | 52
Vertical Bends | 54
Support Structures | 55

CONVEYORS - ELEVATION CHANGE | 57

Topper Lift | 58
Outrunner Spiral | 59
Helical Curve | 60
Wedge Unit | 61

CONVEYORS - DIVERTING & MERGING | 63

Powered Divert | 64
Transpositor | 65
Vertical Switch | 66
Pushers & Squeeze Stops | 67
High Speed Switch | 68

CONVEYORS - SPECIALTY | 69

EZSpan Conveyor | 70
Twist Conveyor | 71
Endless Loop | 72

CONVEYORS - ACCUMULATION | 73

Accumulation | 74

CONVEYORS - DRIVES & GEAR MOTORS | 77

Drives | 78
Intermediate Drives | 79
Hollow Bore Gearmotor | 80
Outrunner Drive | 81
Nord Gearmotors | 82
SEW Gearmotors | 83
More Gearmotor Options | 84

CONVEYORS - ADD ONS | 86

EZGUIDE Guide Rail | 87
Valu Guide Rail | 88
Side Walls | 89
Traffic Cop | 90
Bump Rotate | 91
Metal Detector Section | 92
Variable Frequency Drive | 93
Clean Out Holes | 94
Drip Trays | 94
Low Profile Idler | 95
Lane Dividers | 96
Lexan Safety Guarding | 96

CONVEYORS - TRANSFERS | 97

Gravity Transfer | 98
MicroSpan Transfer | 99
WireMesh Transfer | 100
Horizontal Ballistic Transfer | 101
Offset Ballistic Transfer | 102
Dead Plate Transfer | 103
Transfer Fingers | 104



CHAIN

[GENERAL GUIDELINES]

The information provided are guidelines only. This does not represent all design variations possible. For detailed or specific design requirements ,please contact a representative or email info@spantechllc.com.

CHAIN STRUCTURE

Grid Matrix Design

Span Tech builds its chain on a square matrix. The square matrix allows for fewer parts and chain that can be repaired or replaced in a very short amount of time.

Copy Exact

All chain rods made by Span Tech are identical from one day to the next, from one year to the next. A replacement rod bought 10 years after the sale of the system will be an exact match to the original.

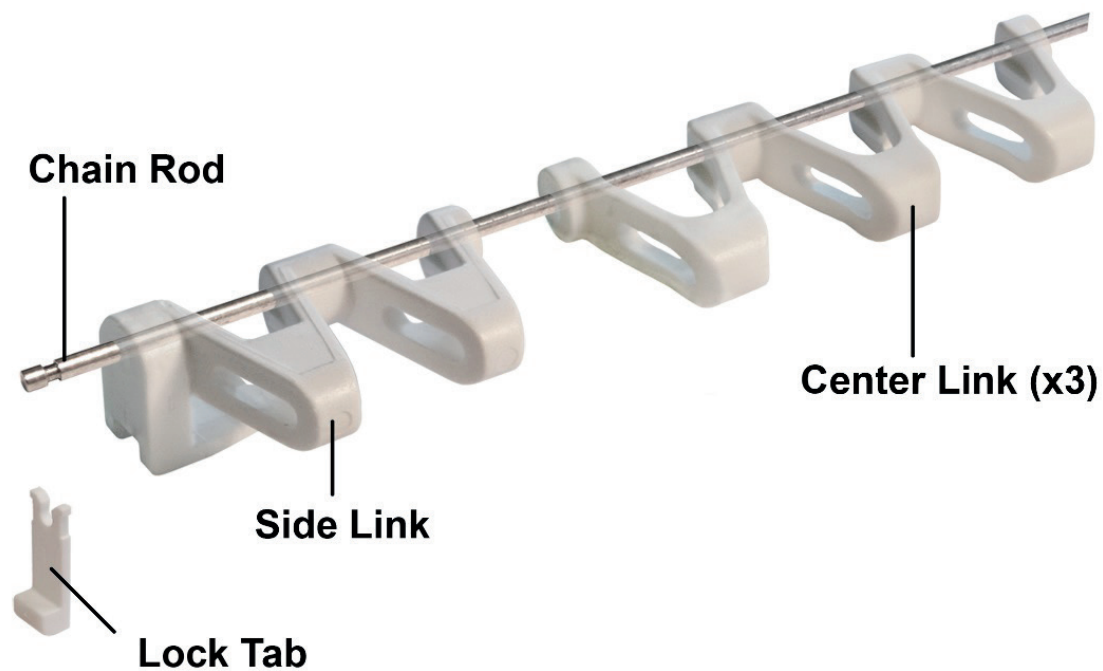

The information provided are guidelines only. This does not represent all design variations possible. For detailed or specific design requirements ,please contact a representative or email info@spantechllc.com.

CHAIN GENERAL

As a rule of thumb, there are four basic types of product movement on a conveyor:

1. **Product Transport**
2. **Product Incline**
3. **Product Decline**
4. **Product Accumulation**

The following guidelines will assist in designing the proper chain options for various applications.

Plain Chain [1A]

Span Tech's plain chain is used for typical product transportation. Plain chain is also ideal for applications requiring accumulation because of its edgeless design. Guide rails are added to retain the product while in accumulation. Most products will normally incline and decline at a grade of 5° without slipping. When steeper angles are necessary, high friction chain should be used.

Pillow Top [1B]

Pillow Top is a perfect application for food production facilities. The innovative Pillow Top design allows the conveyor to sit as close to the transfer unit as possible. This results in successful transferring of very small products which could otherwise get caught or snagged in more traditional transfers.

👍 Pillow Top chain conveyors handle the most delicate products with ease and precision while offering a very tight turning radius for the chain width.

Moving Side Guides [1C]

Moving side guides, which are molded to the left and right side links, move along with the conveyor providing positive retention of products during transportation. Moving side guides also work extremely well with products that move in mass flow, like frozen sausage balls.

👍 Product accumulation cannot occur when moving side guides are used.

👍 Product side to side transfers can not occur when moving side guides are used.

Raised Top Chain [1D]

Span Tech's raised top chain is typically used with finger transfer plates when conveyor end to end transfer of a product is necessary. Raised top chain can also be used to reduce the amount of contact between the chain and product.

Closed Top Chain [1E]

Sometimes you need a conveyor chain with a smooth, closed carrying surface. Closed Top chain adds a measure of safety perfect for operator stations. Closed Top chain has an internal roller which results in extremely low running friction below 70 ft/min. This means you have the option of creating extra long conveyors of 100' or more.

👍 Closed top conveyors are straight running, but can carry heavier products due to its robust design.

Accumulation Chain [1F & 2F]

The accumulation chain option is essential for products requiring low back pressure while the product is stopped and the conveyor continues to run underneath. Back pressure is reduced by approximately 1/2, eliminating chain product damage.

👍 Products can incline or decline up to 2° when using accumulation chain patterns.

👍 Roller chain patterns require plain acetal links to interface with the drive sprockets for pulling the chain around the conveyor.

High Friction Chain [1G]

If a product must be inclined or declined at grades steeper than plain chain will accommodate, a higher friction chain is needed. Since Span Tech chain is modular, the center links can be made of a high friction material. As a rule of thumb, high friction links can incline or decline products a maximum of 25° depending on the products coefficient of friction.

👍 Product accumulation cannot occur when using high friction chain.

👍 High friction chain patterns require plain acetal links to interface with the drive sprockets for pulling the chain around the conveyor

Cleated Chain [1H]

When it is necessary to elevate or lower products at angles greater than the maximum of 25° provided by high friction chain, cleated chain should be used.

The information provided are guidelines only. This does not represent all design variations possible. For detailed or specific design requirements, please contact a representative or email info@spantechllc.com.

CHAIN GENERAL

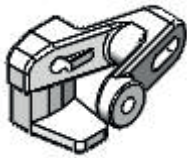

[1A]

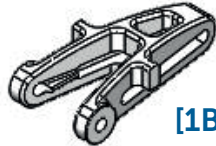

[1B]



[1C]



[1D]

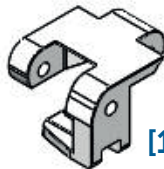

[1E]

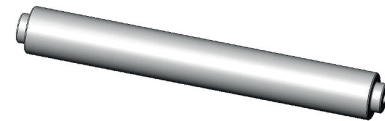

[1F]

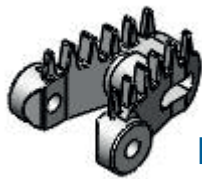

[1G]



[1H]



[2F]

The information provided are guidelines only. This does not represent all design variations possible. For detailed or specific design requirements ,please contact a representative or email info@spantechllc.com.

CHAIN DIMENSIONS

The following illustrations are plan views of chain for each conveyor type within the Span Tech family of conveyors. The dimensions shown represent basic openings for each particular type of chain.

Please use the following rules when determining product size limitations for general transport and accumulate functions for each of the conveyor types within the Span Tech family.

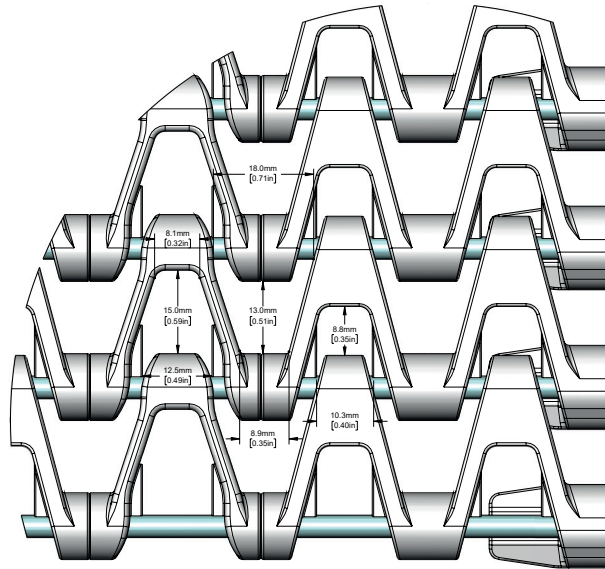

25mm SuperTight

👍 **25mm SuperTight Plain Chain**
Smallest Product Limitation
≥1.0" (25.4mm) Dia.

👍 **25mm SuperTight Raised Top Chain**
Smallest Product Limitation
≥1.125" (28.58mm) Dia.

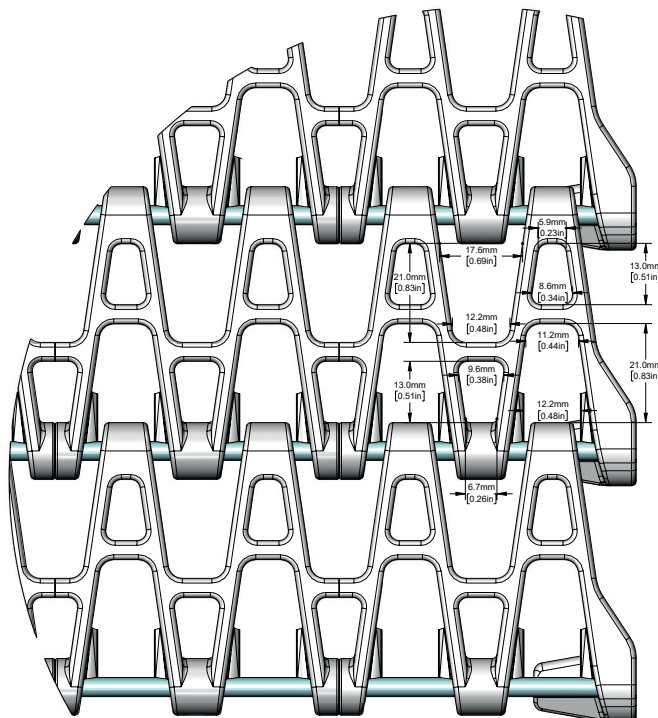

50mm SuperTight

👍 **50mm SuperTight Plain Chain**
Smallest Product Limitation
≥1.0" (25.4mm) Dia.

The information provided are guidelines only. This does not represent all design variations possible. For detailed or specific design requirements, please contact a representative or email info@spantechllc.com.

50mm Pillow Top

👍 **50mm Pillow Top Plain Chain**
Smallest Product Limitation
 $\geq 1.0''$ (25.4mm) Dia.

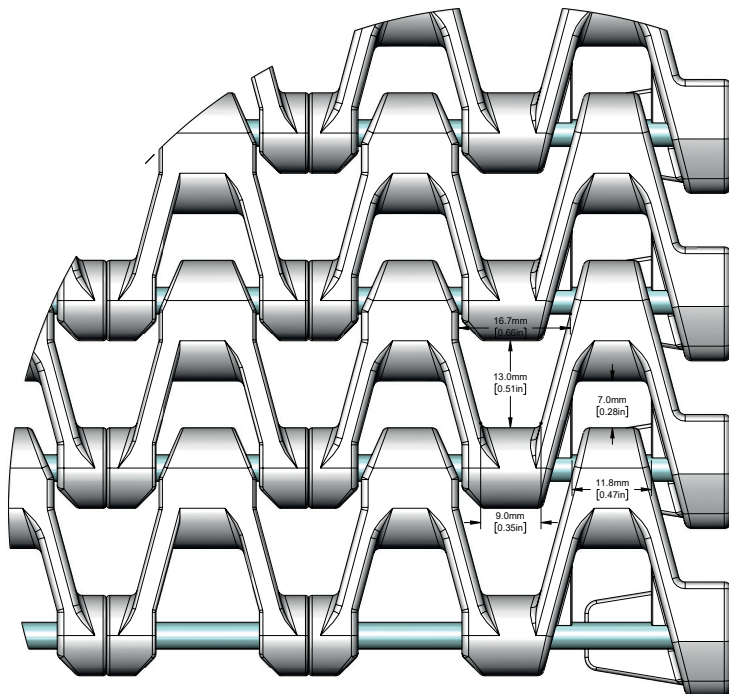
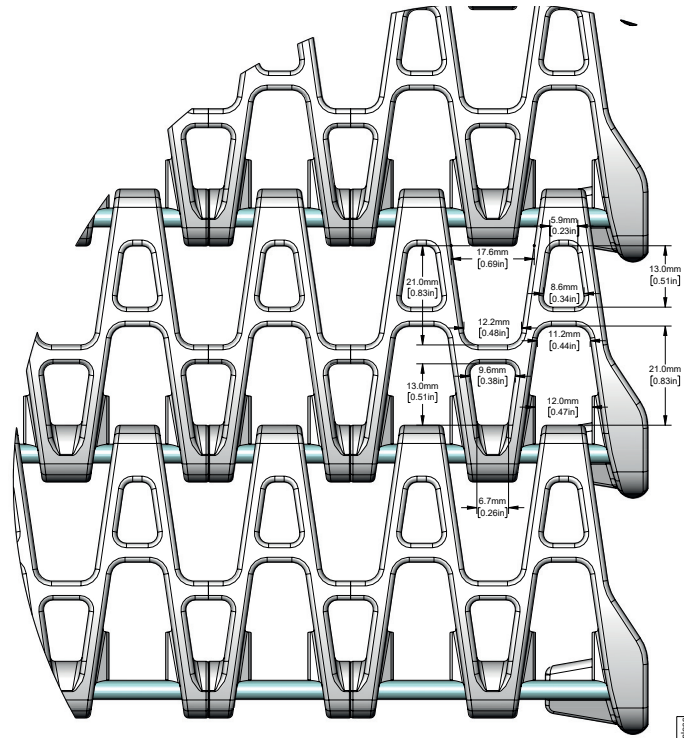

25mm MultiSpan

👍 **MultiSpan Plain Chain**
Smallest Product Limitation
 $\geq 1.0''$ (25.4mm) Dia.

👍 **MultiSpan Raised Top Chain**
Smallest Product Limitation
 $\geq 1.125''$ (28.58mm) Dia.

The information provided are guidelines only. This does not represent all design variations possible. For detailed or specific design requirements ,please contact a representative or email info@spantechllc.com.

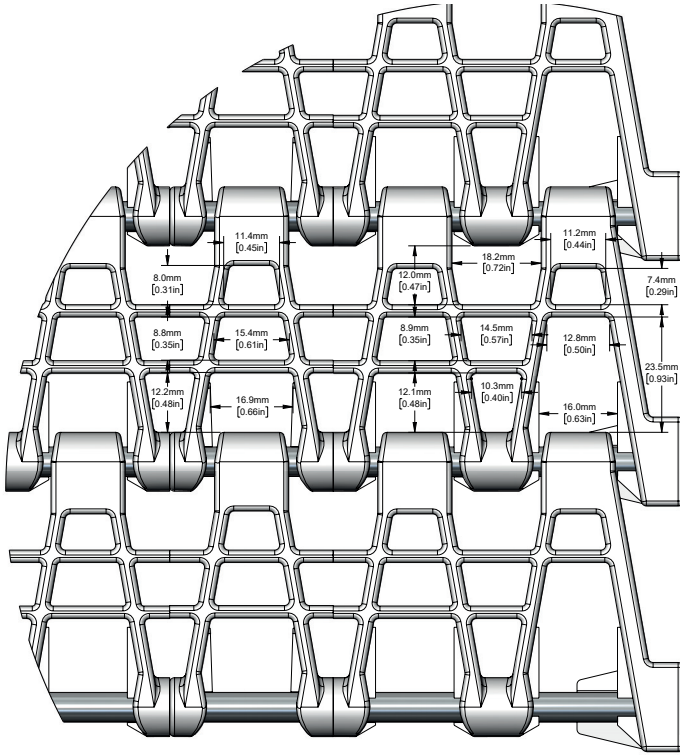

50mm MaxiSpan

MaxiSpan Plain Chain
Smallest Product Limitation
 ≥ 1.0 " (25.4mm) Dia.

MaxiSpan Raised Top Chain
Smallest Product Limitation
 ≥ 1.75 " (44.45mm) Dia.

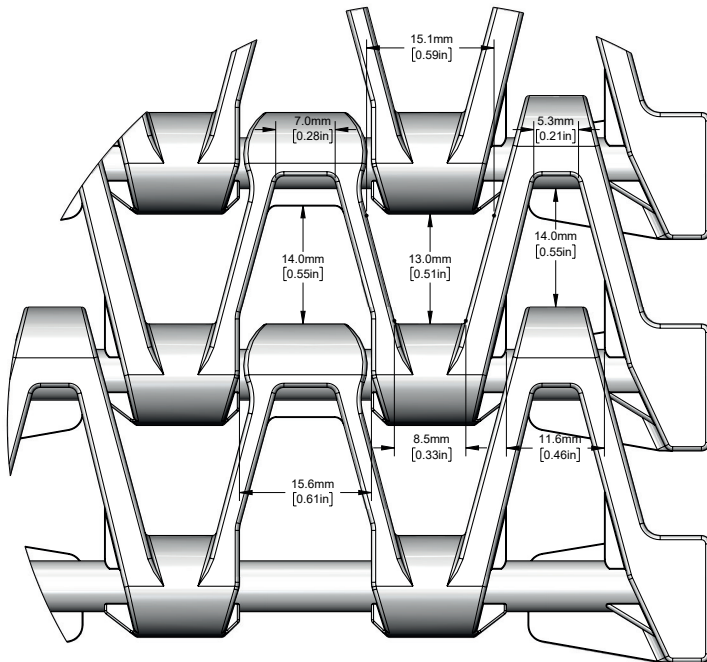

25mm MonoSpan

MonoSpan Plain Chain
Smallest Product Limitation
 ≥ 1.0 " (25.4mm) Dia or Sq.

MonoSpan Raised Top Chain
Smallest Product Limitation
 ≥ 1.125 " (28.58mm) Dia.

standard width
3.76" (95.6mm)

The information provided are guidelines only. This does not represent all design variations possible. For detailed or specific design requirements, please contact a representative or email info@spantechllc.com.

CHAIN GUIDELINES

The absolute minimum centerline turning radius for any of Span Tech conveyors is 18.0" (457.20mm) for aluminum framing and 21.0" (533.40mm) for stainless steel framing.

Chain Width inches	Chain Width MM	No. of Sprockets	Chain Support Rails Top	Chain Support Rails Return	Horizontal Bend Centerline Radius Aluminum (Inches)	Horizontal Bend Centerline Radius Stainless Steel (Inches)	Helical Bend Centerline Radius (Inches)
3.76	95.6	1	0	0	18	21	33.88
4.94	125.6	2	0	0	18	21	34.47
6.13	155.6	2	0	0	18	21	35.06
7.31	185.6	2	0	0	18	21	35.65
8.49	215.6	2	0	0	18	21	36.24
9.67	245.6	2	0	0	19.50	21	36.83
10.85	275.6	2	0	0	22.21	22.21	37.43
12.03	305.6	3	0	0	24.91	24.91	38.02
13.21	335.6	3	1	0	27.61	27.61	38.61
14.39	365.6	3	1	0	30.31	30.31	39.20
15.57	395.6	3	1	0	33.02	33.02	39.79
16.76	425.6	3	1	0	35.74	35.74	40.38
17.94	455.6	4	2	0	38.44	38.44	40.97
19.12	485.6	4	2	0	41.15	41.15	41.56
20.30	515.6	4	2	0	43.85	43.85	43.85
21.48	545.6	5	3	0	46.55	46.55	46.55
22.66	575.6	5	3	0	49.25	49.25	49.25
23.84	605.6	5	3	0	51.95	51.95	51.95
25.02	635.6	5	3	1	54.66	54.66	54.66
26.20	665.6	5	3	1	57.36	57.36	57.36
27.39	695.6	5	3	1	60.08	60.08	60.08
28.57	725.6	5	3	1	62.79	62.79	62.79
29.75	755.6	5	3	1	65.49	65.49	65.49
30.93	785.6	5	3	1	68.19	68.19	68.19
32.11	815.6	5	3	1	70.89	70.89	70.89
33.29	845.6	6	4	1	73.59	73.59	73.59
34.47	875.6	6	4	1	76.30	76.30	76.30
35.65	905.6	6	4	1	79.00	79.00	79.00
36.83	935.6	6	4	1	81.70	81.70	81.70
38.02	965.6	7	5	1	84.43	84.43	84.43
39.20	995.6	7	5	1	87.13	87.13	87.13
40.38	1025.6	7	5	1	89.83	89.83	89.83
41.56	1055.6	7	5	1	92.53	92.53	92.53
42.74	1085.6	7	5	1	95.24	95.24	95.24
43.92	1115.6	7	5	1	97.94	97.94	97.94
45.10	1145.6	7	5	1	100.64	100.64	100.64
46.28	1175.6	7	5	1	103.34	103.34	103.34
47.46	1205.6	8	6	2	106.04	106.04	106.04

25mm SuperTight Centerline Bend Radius = CW (in) * 2.29 - 2.64"

25MM SUPERTIGHT

The information provided are guidelines only. This does not represent all design variations possible. For detailed or specific design requirements ,please contact a representative or email info@spantechllc.com.

Chain Width inches	Chain Width MM	No. of Sprockets	Chain Support Rails Top	Chain Support Rails Return	Horizontal Bend Centerline Radius Aluminum (Inches)	Horizontal Bend Centerline Radius Stainless Steel (Inches)	Helical Bend Centerline Radius (Inches)
3.76	95.6	1	0	0	18	21	33.88
4.94	125.6	2	0	0	18	21	34.47
6.13	155.6	2	0	0	18	21	35.06
7.31	185.6	2	0	0	18	21	35.65
8.49	215.6	2	0	0	18	21	36.24
9.67	245.6	2	0	0	18.66	21	36.83
10.85	275.6	2	0	0	20.94	21	37.43
12.03	305.6	3	0	0	23.22	23.22	38.02
13.21	335.6	3	1	0	25.50	25.50	38.61
14.39	365.6	3	1	0	27.77	27.77	39.20
15.57	395.6	3	1	0	30.05	30.05	39.79
16.76	425.6	3	1	0	32.35	32.35	40.38
17.94	455.6	4	2	0	34.62	34.62	40.97
19.12	485.6	4	2	0	36.90	36.90	41.56
20.30	515.6	4	2	0	39.18	39.18	42.15
21.48	545.6	5	3	0	41.46	41.46	42.74
22.66	575.6	5	3	0	43.73	43.73	43.33
23.84	605.6	5	3	0	46.01	46.01	43.92
25.02	635.6	5	3	1	48.29	48.29	45.66
26.20	665.6	5	3	1	50.57	50.57	47.94
27.39	695.6	5	3	1	52.86	52.86	52.86
28.57	725.6	5	3	1	55.14	55.14	55.14
29.75	755.6	5	3	1	57.42	57.42	57.42
30.93	785.6	5	3	1	59.70	59.70	59.70
32.11	815.6	5	3	1	61.97	61.97	61.97
33.29	845.6	6	4	1	64.25	64.25	64.25
34.47	875.6	6	4	1	66.53	66.53	66.53
35.65	905.6	6	4	1	68.81	68.81	68.81
36.83	935.6	6	4	1	71.08	71.08	71.08
38.02	965.6	7	5	1	73.38	73.38	73.38
39.20	995.6	7	5	1	75.66	75.66	75.66
40.38	1025.6	7	5	1	77.93	77.93	77.93
41.56	1055.6	7	5	1	80.21	80.21	80.21
42.74	1085.6	7	5	1	82.49	82.49	82.49
43.92	1115.6	7	5	1	84.77	84.77	84.77
45.10	1145.6	7	5	1	87.04	87.04	87.04
46.28	1175.6	7	5	1	89.32	89.32	89.32
47.46	1205.6	8	6	2	91.60	91.60	91.60
50mm SuperTight Centerline Bend Radius = CW (in) * 1.93							

50MM SUPERTIGHT

The information provided are guidelines only. This does not represent all design variations possible. For detailed or specific design requirements, please contact a representative or email info@spantechllc.com.

Chain Width inches	Chain Width MM	No. of Sprockets	Chain Support Rails Top	Chain Support Rails Return
3.76	95.6	1	0	0
4.94	125.6	2	0	0
6.13	155.6	2	0	0
7.31	185.6	2	0	0
8.49	215.6	2	0	0
9.67	245.6	2	0	0
10.85	275.6	2	0	0
12.03	305.6	3	0	0
13.21	335.6	3	1	0
14.39	365.6	3	1	0
15.57	395.6	3	1	0
16.76	425.6	3	1	0
17.94	455.6	4	2	0
19.12	485.6	4	2	0
20.30	515.6	4	2	0
21.48	545.6	5	3	0
22.66	575.6	5	3	0
23.84	605.6	5	3	0
25.02	635.6	5	3	1
26.20	665.6	5	3	1
27.39	695.6	5	3	1
28.57	725.6	5	3	1
29.75	755.6	5	3	1
30.93	785.6	5	3	1
32.11	815.6	5	3	1
33.29	845.6	6	4	1
34.47	875.6	6	4	1
35.65	905.6	6	4	1
36.83	935.6	6	4	1
38.02	965.6	7	5	1
39.20	995.6	7	5	1
40.38	1025.6	7	5	1
41.56	1055.6	7	5	1
42.74	1085.6	7	5	1
43.92	1115.6	7	5	1
45.10	1145.6	7	5	1
46.28	1175.6	7	5	1
47.46	1205.6	8	6	2

CLOSED TOP

The information provided are guidelines only. This does not represent all design variations possible. For detailed or specific design requirements ,please contact a representative or email info@spantechllc.com.

Chain Width inches	Chain Width MM	No. of Sprockets	Chain Support Rails Top	Chain Support Rails Return	Horizontal Bend Centerline Radius Aluminum (Inches)	Horizontal Bend Centerline Radius Stainless Steel (Inches)	Helical Bend Centerline Radius (Inches)
3.76	95.6	1	0	0	18	21	33.88
4.94	125.6	2	0	0	18	21	34.47
6.13	155.6	2	0	0	19.12	21	35.06
7.31	185.6	2	0	0	22.80	22.80	35.65
8.49	215.6	2	0	0	26.48	26.48	36.24
9.67	245.6	2	0	0	30.17	30.17	36.83
10.85	275.6	2	0	0	33.85	33.85	37.43
12.03	305.6	3	0	0	37.53	37.53	38.02
13.21	335.6	3	1	0	41.22	41.22	41.22
14.39	365.6	3	1	0	44.90	44.90	44.90
15.57	395.6	3	1	0	48.58	48.58	48.58
16.76	425.6	3	1	0	52.29	52.29	52.29
17.94	455.6	4	2	0	55.97	55.97	55.97
19.12	485.6	4	2	0	59.65	59.65	59.65
20.30	515.6	4	2	0	63.33	63.33	63.33
21.48	545.6	5	3	0	67.02	67.02	67.02
22.66	575.6	5	3	0	70.70	70.70	70.70
23.84	605.6	5	3	0	74.38	74.38	74.38
25.02	635.6	5	3	1	78.06	78.06	78.06
26.20	665.6	5	3	1	81.74	81.74	81.74
27.39	695.6	5	3	1	85.46	85.46	85.46
28.57	725.6	5	3	1	89.14	89.14	89.14
29.75	755.6	5	3	1	92.82	92.82	92.82
30.93	785.6	5	3	1	96.5	96.5	96.5
32.11	815.6	5	3	1	100.18	100.18	100.18
33.29	845.6	6	4	1	103.87	103.87	103.87
34.47	875.6	6	4	1	107.55	107.55	107.55
35.65	905.6	6	4	1	111.23	111.23	111.23
36.83	935.6	6	4	1	114.91	114.91	114.91
38.02	965.6	7	5	1	118.62	118.62	118.62
39.20	995.6	7	5	1	122.30	122.30	122.30
40.38	1025.6	7	5	1	125.99	125.99	125.99
41.56	1055.6	7	5	1	129.67	129.67	129.67
42.74	1085.6	7	5	1	133.35	133.35	133.35
43.92	1115.6	7	5	1	137.03	137.03	137.03
45.10	1145.6	7	5	1	140.71	140.71	140.71
46.28	1175.6	7	5	1	144.39	144.39	144.39
47.46	1205.6	8	6	2	148.08	148.08	148.08
MultiSpan Centerline Bend Radius = CW (in)*3.12							

MULTISPAN

The information provided are guidelines only. This does not represent all design variations possible. For detailed or specific design requirements, please contact a representative or email info@spantechllc.com.

Chain Width inches	Chain Width MM	No. of Sprockets	Chain Support Rails Top	Chain Support Rails Return	Horizontal Bend Centerline Radius Aluminum (Inches)	Horizontal Bend Centerline Radius Stainless Steel (Inches)
8.24	209.2	2	2	0	21.75	21.75
12.17	309.2	3	3	0	35.45	35.45
16.11	409.2	4	4	0	49.15	49.15
20.05	509.2	5	5	0	62.85	62.85
23.98	609.2	6	6	1	76.56	76.56
27.92	709.2	7	7	1	90.26	90.26
31.86	809.2	8	8	1	103.96	103.96
35.80	909.2	9	9	1	117.66	117.66
39.73	1009.2	10	10	1	131.36	131.36
43.67	1109.2	11	11	1	145.06	145.06
47.61	1209.2	12	12	1	158.76	158.76
Maxispán Centerline Bend Radius = CW (in) * 3.48 - 6.91"						

MAXISPAN

Chain Width inches	Chain Width MM	No. of Sprockets	Chain Support Rails Top	Chain Support Rails Return	Horizontal Bend Centerline Radius Aluminum (Inches)	Horizontal Bend Centerline Radius Stainless Steel (Inches)
3.76	95.6	1	0	0	21	21
7.53	191.26	2	0	0	23.49	23.49
11.29	286.77	2	0	0	35.22	35.22
15.06	382.52	2	0	0	46.99	46.99
MultiSpan Centerline Bend Radius = CW (in)*3.12						

MONOSPAN

The information provided are guidelines only. This does not represent all design variations possible. For detailed or specific design requirements, please contact a representative or email info@spantechllc.com.

CHAIN TYPES

[SUPERTIGHT CHAIN]

The information provided are guidelines only. This does not represent all design variations possible. For detailed or specific design requirements ,please contact a representative or email info@spantechllc.com.

25MM SUPERTIGHT CHAIN

Light, economical chain for many standard applications.

Material Options

Available in acetal, santoprene, and polyurethane.

Tight Turning Radius

SuperTight Chain has a tighter horizontal bend radius than MultiSpan.

25mm SuperTight Centerline Radius Formula
 Chain Width (in) * 2.29-2.64"

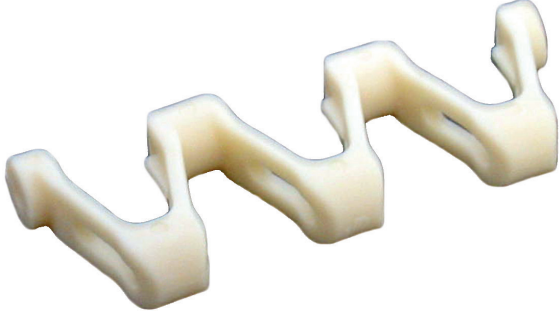

Durable

SuperTight Chain is very lightweight yet very strong.

Sanitary

The open design concept improves cleanability.

Cost Effective

SuperTight Chain has all the versatility of regular MultiSpan Chain but more cost effective.

SPECIFICATIONS FOR 25MM SUPERTIGHT CHAIN

- SuperTight Plain Chain has a weight of 1.9 lbs/ft² and has a load carrying capacity of 50 lbs/ft². SuperTight Chain is connected by 4mm diameter stainless and plastic chain lock tabs.
- Santoprene material is ideal for glossy, finished or printed cardboard, plastic containers or metal.

CHAIN OPTIONS:

- Plain (White or Blue)
- 6mm Raised Top
- 6mm Moving Side Guide
- 30mm Moving Side Guide
- 75mm Moving Side Guide
- Plain High Friction
- 6mm Raised Top High Friction
- 6mm Brush Top High Friction
- 10mm Brush Top High Friction

PITCH

- 25mm (0.98")

AVAILABLE WIDTH RANGE

- 95.6mm - 1205.6mm (3.76" - 47.46")

NOTES:

The information provided are guidelines only. This does not represent all design variations possible. For detailed or specific design requirements, please contact a representative or email info@spantechllc.com.

25MM SUPERTIGHT CHAIN

KEY: C = CENTER • LH = LEFT HAND • RH = RIGHT HAND • MSG = MOVING SIDE GUIDE • (PU) = POLYURETHANE • (S) = SANTOPRENE
 • (A) = ACETAL • (PP) = POLYPROPYLENE

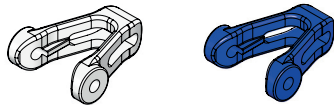

DS-C-ST-PL-1-A
 MST-PLAIN CENTER (A)
DS-C-ST-PL-1-A-BLUE
 MST-PLAIN CENTER BLUE (A)

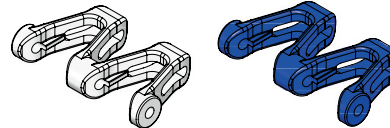

DS-C-ST-PL-2-A
 MST-PLAIN CENTER (A)
DS-C-ST-PL-2-A-BLUE
 MST-PLAIN CENTER BLUE (A)

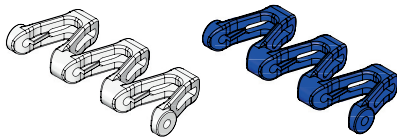

DS-C-ST-PL-3-A
 MST-PLAIN CENTER (A)
DS-C-ST-PL-3-A-BLUE
 MST-PLAIN CENTER BLUE (A)

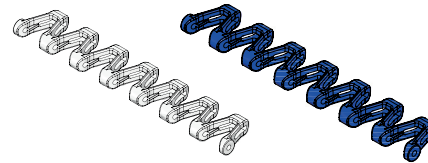

DS0134-02A
 MST-PLAIN CENTER (A)
DS0134-02A-BLUE
 MST-PLAIN CENTER BLUE (A)

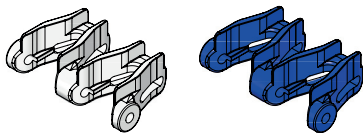

DS-C-ST-6MM-RT-2-A
 MST-6MM RAISED CENTER (A)
DS-C-ST-6MM-RT-2-A-BLUE
 MST-6MM RAISED CENTER BLUE (A)

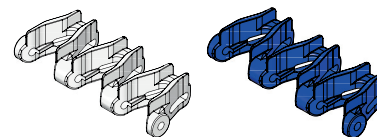

DS-C-ST-6MM-RT-3-A
 MST-6MM RAISED CENTER (A)
DS-C-ST-6MM-RT-3-A-BLUE
 MST-6MM RAISED CENTER BLUE (A)

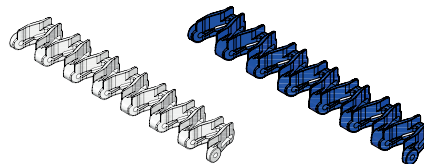

DS0135-02A
 MST-6MM RAISED CENTER (A)
DS0135-02A-BLUE
 MST-6MM RAISED CENTER BLUE (A)

The information provided are guidelines only. This does not represent all design variations possible. For detailed or specific design requirements ,please contact a representative or email info@spantechllc.com.

25MM SUPERTIGHT CHAIN

KEY: C = CENTER • LH = LEFT HAND • RH = RIGHT HAND • MSG = MOVING SIDE GUIDE • (PU) = POLYURETHANE • (S) = SANTOPRENE
 • (A) = ACETAL • (PP) = POLYPROPYLENE

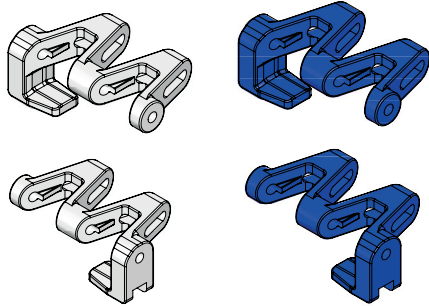

DS0126-02A | MST-LH PLAIN (A)
 DS0126-02A-BLUE | MST-LH PLAIN BLUE (A)
 DS0127-02A | MST-RH PLAIN (A)
 DS0127-02A-BLUE | MST-RH PLAIN BLUE (A)

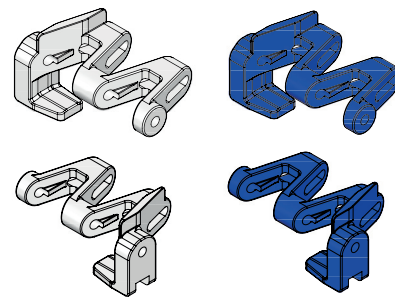

DS0128-03A | MST-LH 6MM MSG (A)
 DS0128-03A-BLUE | MST-LH 6MM MSG BLUE (A)
 DS0129-03A | MST-RH 6MM MSG (A)
 DS0129-03A-BLUE | MST-RH 6MM MSG BLUE (A)

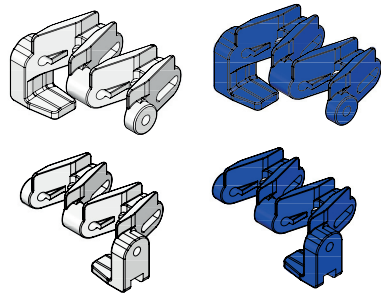

DS0132-02A | MST-LH 6MM RAISED (A)
 DS0132-02A-BLUE | MST-LH 6MM RAISED BLUE (A)
 DS0133-02A | MST - RH 6MM RAISED (A)
 DS0133-02A-BLUE | MST - RH 6MM RAISED BLUE (A)

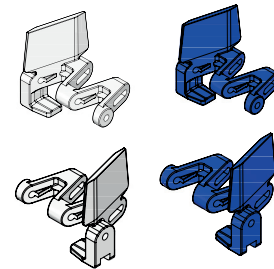

DS0136-01A-30 | MST-LH 30MM MSG (A)
 DS0136-01A-30-BLUE | MST-LH 30MM MSG BLUE (A)
 DS0137-01A-30 | MST-RH 30MM MSG (A)
 DS0137-01A-30-BLUE | MST-RH 30MM MSG BLUE (A)

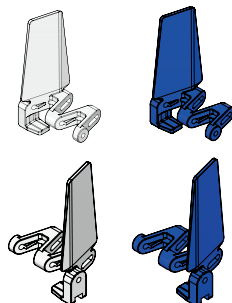

DS0136-01A | MST-LH 75MM MSG (A)
 DS0136-01A-BLUE | MST-LH 75MM MSG BLUE (A)
 DS0137-01A | MST-RH 75MM MSG(A)
 DS0137-01A-BLUE | MST-RH 75MM MSG BLUE (A)

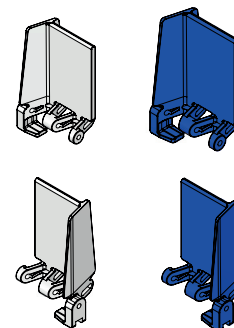

DS0138-01A | MST-LH 75MM MSG/PUSHER (A)
 DS0138-01A-BLUE | MST-LH 75MM MSG/PUSHER BLUE (A)
 DS0139-01A | MST-RH 75MM MSG/PUSHER (A)
 DS0139-01A-BLUE | MST-RH 75MM MSG/PUSHER BLUE (A)

The information provided are guidelines only. This does not represent all design variations possible. For detailed or specific design requirements, please contact a representative or email info@spantechllc.com.

25MM SUPERTIGHT CHAIN [HIGH FRICTION SANTOPRENE]

KEY: C = CENTER • LH = LEFT HAND • RH = RIGHT HAND • MSG = MOVING SIDE GUIDE • (PU) = POLYURETHANE • (S) = SANTOPRENE
• (A) = ACETAL • (PP) = POLYPROPYLENE

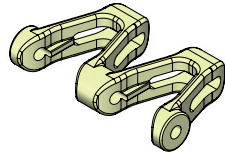

DS-C-ST-PL-2-S
MST-PLAIN HF CENTER 55D (S)

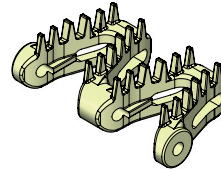

DS-C-ST-6MM-BT-2-S
MST-6MM BRUSH TOP CENTER 55D (S)

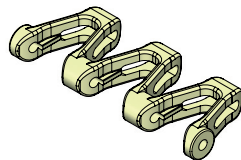

DS-C-ST-PL-3-S
MST-PLAIN HF CENTER 55D (S)

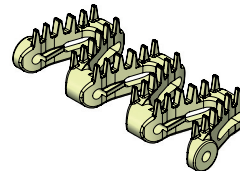

DS-C-ST-6MM-BT-3-S
MST-6MM BRUSH TOP CENTER 55D (S)

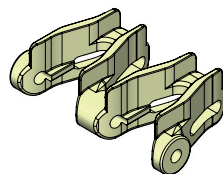

DS-C-ST-6MM-RT-2-S
MST-6MM RAISED CENTER 55D (S)

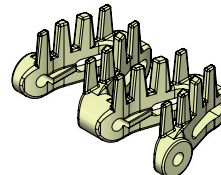

DS-C-ST-10MM-BT-2-S
MST-10MM BRUSH TOP CENTER 55D (S)

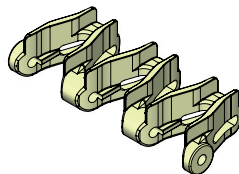

DS-C-ST-6MM-RT-3-S
MST-6MM RAISED CENTER 55D (S)

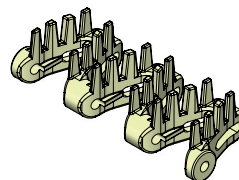

DS-C-ST-10MM-BT-3-S
MST-10MM BRUSH TOP CENTER 55D (S)

The information provided are guidelines only. This does not represent all design variations possible. For detailed or specific design requirements ,please contact a representative or email info@spantechllc.com.

25MM SUPERTIGHT CHAIN [HIGH FRICTION POLYURETHANE]

KEY: C = CENTER • LH = LEFT HAND • RH = RIGHT HAND • MSG = MOVING SIDE GUIDE • (PU) = POLYURETHANE • (S) = SANTOPRENE
• (A) = ACETAL • (PP) = POLYPROPYLENE

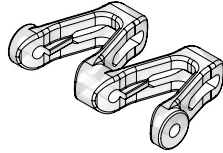

DS-C-ST-PL-2-PU
MST-PLAIN HF CENTER 85D (PU)

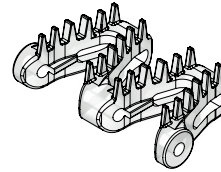

DS-C-ST-6MM-BT-2-PU
MST-6MM BRUSH TOP CENTER 85D (PU)

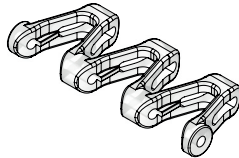

DS-C-ST-PL-3-PU
MST-PLAIN HF CENTER 85D (PU)

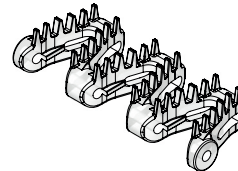

DS-C-ST-6MM-BT-3-PU
MST-6MM BRUSH TOP CENTER 85D (PU)

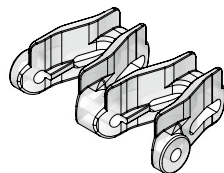

DS-C-ST-6MM-RT-2-PU
MST-6MM RAISED CENTER 85D (PU)

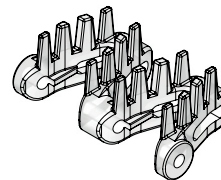

DS-C-ST-10MM-BT-2-PU
MST-10MM BRUSH TOP CENTER 85D (PU)

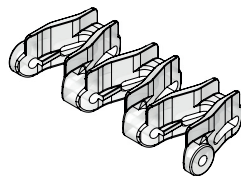

DS-C-ST-6MM-RT-3-PU
MST-6MM RAISED CENTER 85D (PU)

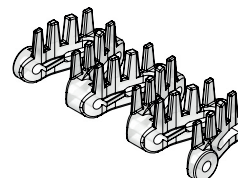

DS-C-ST-10MM-BT-3-PU
MST-10MM BRUSH TOP CENTER 85D (PU)

The information provided are guidelines only. This does not represent all design variations possible. For detailed or specific design requirements, please contact a representative or email info@spantechllc.com.

50MM SUPERTIGHT CHAIN

Perfect solution for applications where a low cost, high performance conveyor is needed.

Material Options

Acetal side links and polypropylene center links.

Tight Turning Radius

50mm SuperTight chain has the tightest turning radius that Span Tech offers.

Durable

50mm SuperTight chain is very lightweight yet very strong.

Sanitary

The open design concept improves cleanability.

Cost Effective

50mm SuperTight chain uses half the number of rods, making it more cost effective than our 25mm pitch chains.



SPECIFICATIONS FOR 50MM SUPERTIGHT CHAIN

- 50mm SuperTight chain has an open rod design allowing for good airflow, thus making it perfect for cooling or drying applications.
- 50mm SuperTight chain is a perfect fit for food & beverage production, packaging, & e-commerce.

NOTES:

CHAIN OPTIONS:

- Plain (White or Blue)

PITCH

- 50mm (1.97")

AVAILABLE WIDTH RANGE

- 95.6mm - 1205.68mm (3.76" - 47.46")

The information provided are guidelines only. This does not represent all design variations possible. For detailed or specific design requirements, please contact a representative or email info@spantechllc.com.

50MM SUPERTIGHT CHAIN

KEY: C = CENTER • LH = LEFT HAND • RH = RIGHT HAND • MSG = MOVING SIDE GUIDE • (PU) = POLYURETHANE • (S) = SANTOPRENE
• (A) = ACETAL • (PP) = POLYPROPYLENE

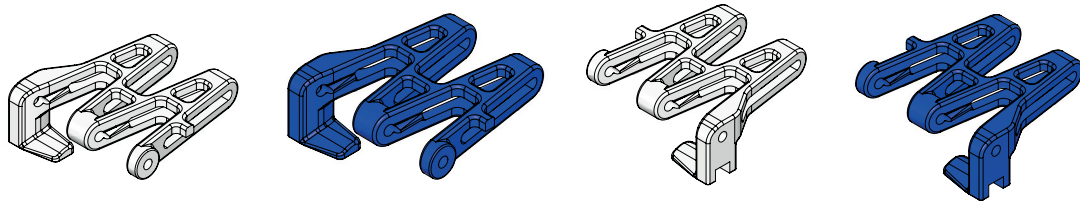

DS0142A | MST-LH PLAIN 50MM SUPERTIGHT (A)
DS0142A-BLUE | MST-LH PLAIN 50MM SUPERTIGHT BLUE (A)
DS0143A | MST-RH PLAIN 50MM SUPERTIGHT (A)
DS0143A-BLUE | MST-RH PLAIN 50MM SUPERTIGHT BLUE (A)

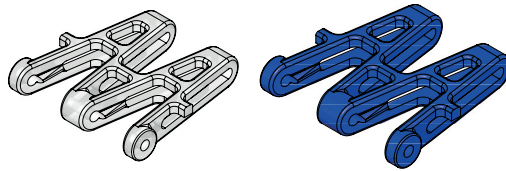

DS0011P-2V | MST-PLAIN CENTER 50MM SUPERTIGHT (PP)
DS0011P-2V-BLUE | MST-PLAIN CENTER 50MM SUPERTIGHT BLUE (PP)

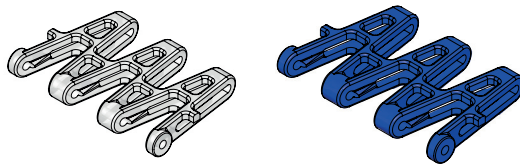

DS0011P-3V | MST-PLAIN CENTER 50MM SUPERTIGHT (PP)
DS0011P-3V-BLUE | MST-PLAIN CENTER 50MM SUPERTIGHT BLUE (PP)

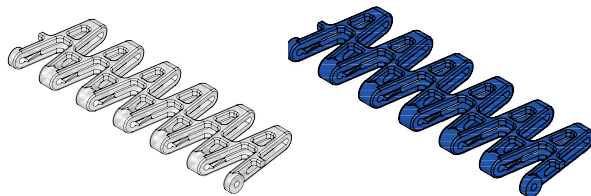

DS0011P | MST-PLAIN CENTER 50MM SUPERTIGHT (PP)
DS0011P-BLUE | MST-PLAIN CENTER 50MM SUPERTIGHT BLUE (PP)

The information provided are guidelines only. This does not represent all design variations possible. For detailed or specific design requirements, please contact a representative or email info@spantechllc.com.

50MM PILLOWTOP CHAIN

Handles the most delicate of products with ease and precision.

Material Options

Acetal, santoprene, & polyurethane

Tight Turning Radius

50mm PillowTop chain has one of the tighter turning radii that Span Tech offers.

Durable

50mm PillowTop Chain is very lightweight yet very strong.

Sanitary

The open design concept improves cleanability and makes it perfect for cooling applications.



SPECIFICATIONS FOR 50MM PILLOWTOP CHAIN

- 50mm PillowTop chain has a curved design which significantly reduces chordal action allowing transfers to be positioned extremely close to the chain. This makes Pillow Top chain a good fit for food industries specifically with thin products such as tortillas and cookies.

- 50mm PillowTop chain paired with a dead plate transfer allows for a more cost effective method of transferring small products.

- PillowTop chain can easily replace any 50mm SuperTight chain.

CHAIN OPTIONS:

- Plain (White or Blue)
- Moving Side Guide (White or Blue)
- Santoprene High Friction
- Polyurethane High Friction

PITCH

- 50mm (1.97")

AVAILABLE WIDTH RANGE

- 95.6mm - 1205.6mm (3.76" - 47.46")

NOTES:

The information provided are guidelines only. This does not represent all design variations possible. For detailed or specific design requirements ,please contact a representative or email info@spantechllc.com.

WHAT IS CHORDAL ACTION?

The rising and lowering of an individual chain link as it enters a sprocket is known as chordal action. The reason it happens is simply due to geometry. When a chain is “wrapped” around a sprocket, the pins of the chain form a polygon shape. When you look at this polygon shape traveling around a sprocket, it is bumpy – not smooth. When a conveyor chain enters a drive sprocket, it goes from a flat line to this polygon shape and results in a rise/lowering of the pin. This effect can be lessened only by using a smaller pitch chain, or increasing the sprocket size – it cannot be prevented. Depending on the elevation of the chain (in relation to the sprocket), we can control whether the chain “rises” or “lowers” to match this polygon shape.

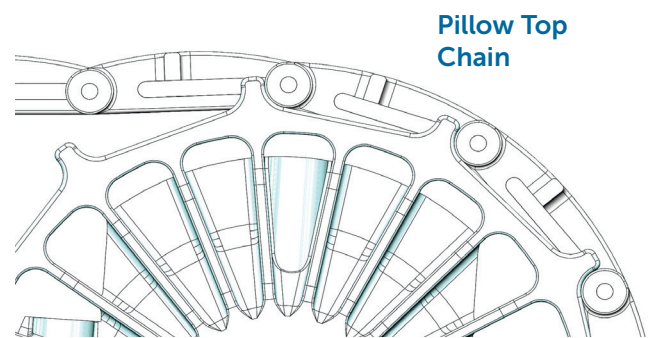
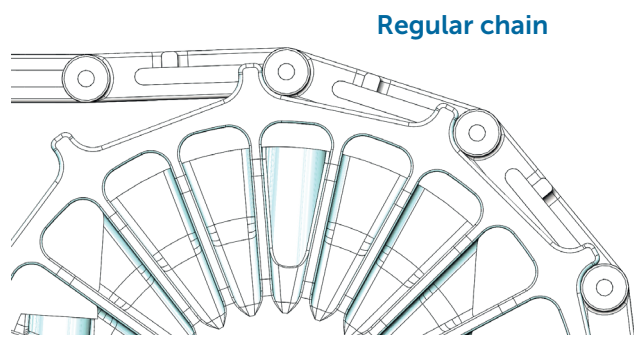

ADDITIONAL NOTES:

The information provided are guidelines only. This does not represent all design variations possible. For detailed or specific design requirements, please contact a representative or email info@spantechllc.com.

50MM PILLOWTOP CHAIN

KEY: C = CENTER • LH = LEFT HAND • RH = RIGHT HAND • MSG = MOVING SIDE GUIDE • (PU) = POLYURETHANE • (S) = SANTOPRENE
• (A) = ACETAL • (PP) = POLYPROPYLENE

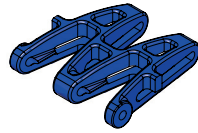
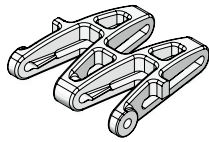

DS0162A-2V
50MM SUPERTIGHT PILLOW TOP LINK CENTER (A)
DS0162A-2V-BLUE
50MM SUPERTIGHT PILLOW TOP LINK CENTER BLUE (A)

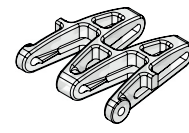
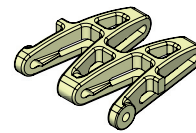

DS0162S-2V
50 MM SUPERTIGHT PILLOW TOP LINK CENTER (S)
DS0162PU-2V
50 MM SUPERTIGHT PILLOW TOP LINK CENTER (PU)

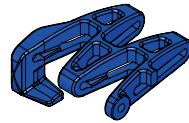
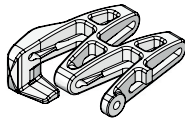

DS0160A
50MM SUPERTIGHT PILLOW TOP LH (A)
DS0160A-BLUE
50MM SUPERTIGHT PILLOW TOP LH - BLUE (A)

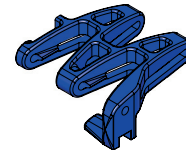
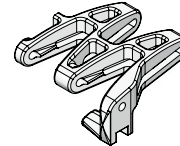

DS0161A
50MM SUPERTIGHT PILLOW TOP RH
DS0161A-BLUE
50MM SUPERTIGHT PILLOW TOP RH - BLUE

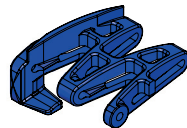
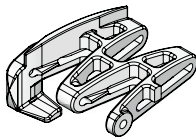

DS0163A
50MM SUPERTIGHT PILLOW TOP MSG - LEFT (A)
DS0163A-BLUE
50MM SUPERTIGHT PILLOW TOP MSG - LEFT BLUE (A)

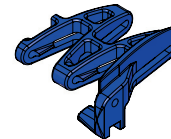
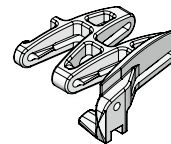

DS0164A
50MM SUPERTIGHT PILLOW TOP MSG - RIGHT (A)
DS0164A-BLUE
50MM SUPERTIGHT PILLOW TOP MSG - RIGHT BLUE (A)

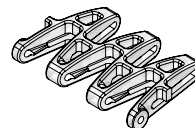
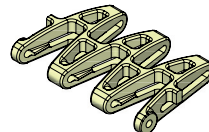

DS0162S-3V
50 MM SUPERTIGHT PILLOW TOP LINK CENTER (S)
DS0162PU-3V
50 MM SUPERTIGHT PILLOW TOP LINK CENTER (PU)

The information provided are guidelines only. This does not represent all design variations possible. For detailed or specific design requirements ,please contact a representative or email info@spantechllc.com.

TUBE TOP ROLLER

Used in applications where the product needs to accumulate.

Reduced Back Pressure

TubeTop Rollers reduce back pressure allowing products to accumulate easily without damage.

Durable

TubeTop Rollers are very lightweight yet durable.



SPECIFICATIONS FOR TUBETOP ROLLERS

- Tube Top is perfect for applications where products need to accumulate on the conveyor.
- The tubes rotate freely on the stainless steel rods, acting as a roller allowing the chain to easily run under a stationary product without damaging it.
- TubeTop can incline or decline 2°.

NOTES:

The information provided are guidelines only. This does not represent all design variations possible. For detailed or specific design requirements, please contact a representative or email info@spantechllc.com.

TUBE TOP ROLLER & ACCUMULATION OPTIONS

KEY: C = CENTER • LH = LEFT HAND • RH = RIGHT HAND • MSG = MOVING SIDE GUIDE • (PU) = POLYURETHANE • (S) = SANTOPRENE
• (A) = ACETAL • (PP) = POLYPROPYLENE

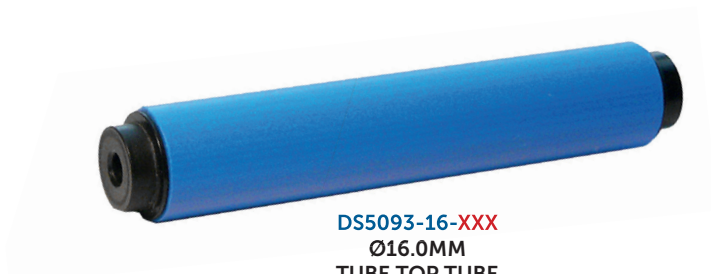

DS5093-16-XXX
Ø16.0MM
TUBE TOP TUBE
XXX = LENGTH OF TUBE
REFER TO CHAIN DRAWING FOR LENGTH



DS0054-01A
Ø16.0MM
TUBE TOP BEARING
(A) CENTER LINK

OTHER ACCUMULATION OPTIONS:



DS0053P
MUS - 16MM BARREL ROLLER (PP)

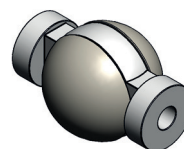

DA7000
MUS - SPHERICAL ROLLER
ASSEMBLY

The information provided are guidelines only. This does not represent all design variations possible. For detailed or specific design requirements ,please contact a representative or email info@spantechllc.com.

ADDITIONAL NOTES:

The information provided are guidelines only. This does not represent all design variations possible. For detailed or specific design requirements, please contact a representative or email info@spantechllc.com.

CHAIN TYPES

[LEGACY CHAIN]

The information provided are guidelines only. This does not represent all design variations possible. For detailed or specific design requirements ,please contact a representative or email info@spantechllc.com.

MULTISPAN CHAIN

A strong and versatile solution with a compact design.



Material Options

Available in acetal, santoprene, and polyurethane.

Versatile

With a large amount of chain types available, it can be used in many different applications.

Durable

MultiSpan chain is very lightweight yet very strong.

Sanitary

The open design concept improves cleanability.

SPECIFICATIONS FOR MULTISPAN CHAIN

- Multispan uses stainless steel rods.
- Load carrying capacity of 50 lbs/ft².

CHAIN OPTIONS:

- Plain
- Santoprene High Friction
- Polyurethane High Friction
- Moving Side Guide
- Raised Top
- Pusher Cleats
- Brush Top
- Rollers

PITCH

- 25mm (0.98")

AVAILABLE WIDTH RANGE

- FROM 95.6mm - 1205.6mm (3.76" - 47.46")
(30mm increments) (1.18" increments)

NOTES:

The information provided are guidelines only. This does not represent all design variations possible. For detailed or specific design requirements, please contact a representative or email info@spantechllc.com.

MULTISPAN CHAIN

KEY: C = CENTER • LH = LEFT HAND • RH = RIGHT HAND • MSG = MOVING SIDE GUIDE • (PU) = POLYURETHANE • (S) = SANTOPRENE
• (A) = ACETAL • (PP) = POLYPROPYLENE

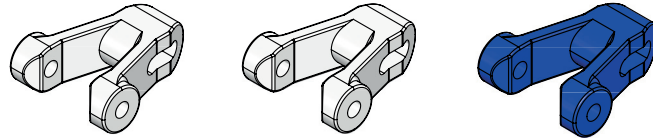

DS0001A | MUS PLAIN CENTER (A)
DS0001P | MUS PLAIN CENTER (PP)
DS0001P-BLUE | MUS - PLAIN BLUE CENTER (PP)

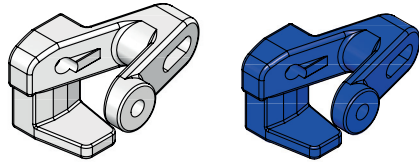

DS0120A | MUS - LH PLAIN (A)
DS0120A-BLUE | MUS - LH PLAIN BLUE (A)

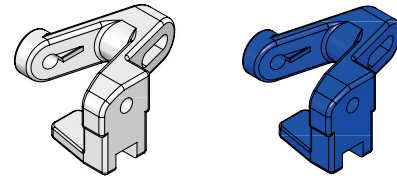

DS0121A | MUS - LH PLAIN (A)
DS0121A-BLUE | MUS - RH PLAIN BLUE (A)

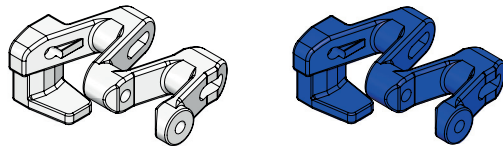

DS0146A | MUS - LH COMBO PLAIN (A)
DS0146A-BLUE | MUS - LH COMBO PLAIN BLUE (A)

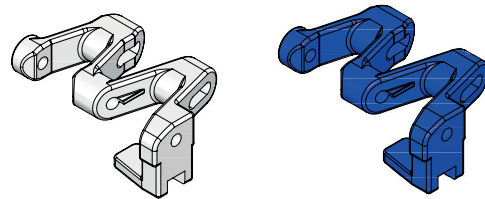

DS0147A | MUS - RH COMBO PLAIN (A)
DS0147A-BLUE | MUS - RH COMBO PLAIN BLUE (A)

The information provided are guidelines only. This does not represent all design variations possible. For detailed or specific design requirements ,please contact a representative or email info@spantechllc.com.

MULTISPAN CHAIN

KEY: C = CENTER • LH = LEFT HAND • RH = RIGHT HAND • MSG = MOVING SIDE GUIDE • (PU) = POLYURETHANE • (S) = SANTOPRENE
• (A) = ACETAL • (PP) = POLYPROPYLENE

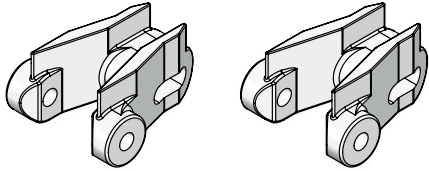

DS0002-01A | MUS - 6MM RAISED CENTER (A)
DS0002P | MUS - 6MM RAISED CENTER (PP)

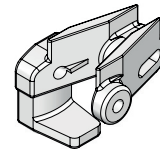

DS0124-01A | MUS - 6MM RAISED LH (A)

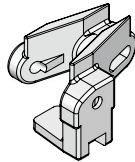

DS0125-01A | MUS - 6MM RAISED RH (A)

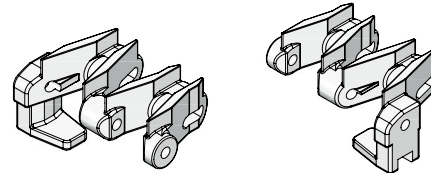

DS0148A | LEFT HAND COMBO 6MM RAISED (A)
DS0149A | RIGHT HAND COMBO 6MM RAISED (A)

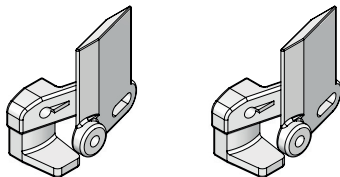

DS0122A | MUS - LH 30MM MSG (A)
DS0122P | MUS - LH 30MM MSG (PP)

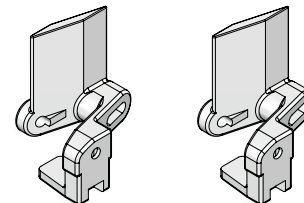

DS0123A | MUS - RH 30MM MSG (A)
DS0123P | MUS - RH 30MM MSG (PP)

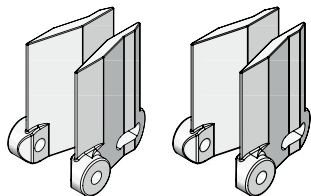

DS0003-01-01A
30MM RAISED CLEAT (A) CENTER (A)
DS0003-01-01P
30MM RAISED CLEAT CENTER (PP)

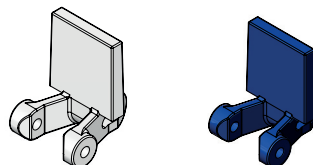

DS0005A
30MM PUSHER CLEAT CENTER (A)
DS0005A-BLUE
30MM PUSHER CLEAT CENTER BLUE (A)

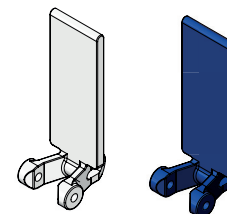

DS0005A-75
75MM PUSHER CLEAT CENTER (A)
DS0005A-75-BLUE
75MM PUSHER CLEAT CENTER BLUE (A)

The information provided are guidelines only. This does not represent all design variations possible. For detailed or specific design requirements, please contact a representative or email info@spantechllc.com.

MULTISPAN CHAIN

KEY: C = CENTER • LH = LEFT HAND • RH = RIGHT HAND • MSG = MOVING SIDE GUIDE • (PU) = POLYURETHANE • (S) = SANTOPRENE
• (A) = ACETAL • (PP) = POLYPROPYLENE

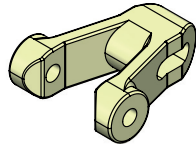

DS0001S55 (55-87)
MUS-PLAIN CENTER (S)
55 OR 87 DUROMETER

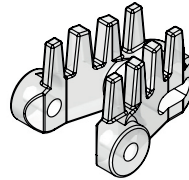

DS0010-BT-PU
MUS-10MM BRUSH TOP CENTER (PU)
70 DUROMETER

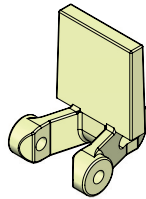

DS0005-(S55-S87)
MUS-30MM PUSHER CLEAT CENTER (S)
55 OR 87 DUROMETER

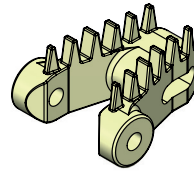

DS0010-BT (55-75)
MUS-10MM BRUSH TOP CENTER (S)
55 OR 75 DUROMETER

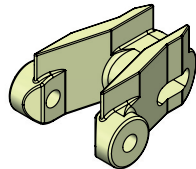

DS0002S-01S (55-87)
MUS-6MM RAISED TOP CENTER (S)
55 OR 87 DUROMETER

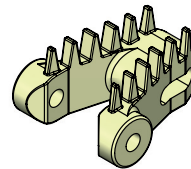

DS0004-01-BT-55
MUS-6MM BRUSH TOP CENTER (S)
55 DUROMETER

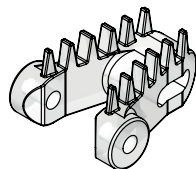

DS0004-BT-PU
MUS-6MM BRUSH TOP CENTER (PU)
70 DUROMETER

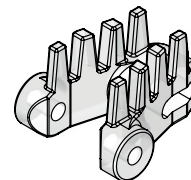

DS0010-BT-PU
MUS-10MM BRUSH TOP CENTER (PU)
70 DUROMETER

The information provided are guidelines only. This does not represent all design variations possible. For detailed or specific design requirements ,please contact a representative or email info@spantechllc.com.

MONOSPAN CHAIN

Your best option for moving small parts.



Material Options

Available in acetal and santoprene.

Versatile

With a large amount of chain types available, it can be used in many different applications.

Durable

MonoSpan chain is very lightweight yet very strong.

Sanitary

The open design concept improves cleanability.

SPECIFICATIONS FOR MONOSPAN CHAIN

- With a 51% open design, MonoSpan allows liquids and debris to fall through and can be washed down while still on the conveyor.
- MonoSpan also has an all plastic design including chain rod making it ideal for use with metal detector sections.
- Load carrying capacity of 15 lbs/linear foot.
- Single link is 95.6mm (3.76") wide.
- Flexible design that can incorporate multiple curves and elevation changes.

CHAIN OPTIONS:

- Plain
- Raised Top
- Santoprene High Friction

PITCH

- 25mm (0.98")

AVAILABLE WIDTH RANGE

- 95.6mm (3.76")
(95.6mm increments) (3.76" increments)

NOTES:

The information provided are guidelines only. This does not represent all design variations possible. For detailed or specific design requirements, please contact a representative or email info@spantechllc.com.

MONOSPAN CHAIN

KEY: C = CENTER • LH = LEFT HAND • RH = RIGHT HAND • MSG = MOVING SIDE GUIDE • (PU) = POLYURETHANE • (S) = SANTOPRENE
• (A) = ACETAL • (PP) = POLYPROPYLENE

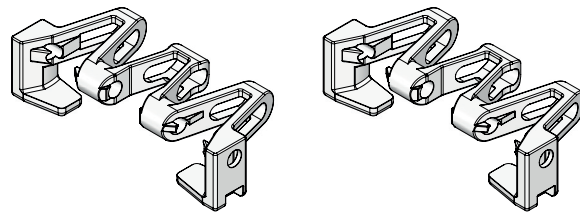

DS0200-01A
MON-PLAIN LINK (A)
DS0200-01P
MON-PLAIN LINK (PP)

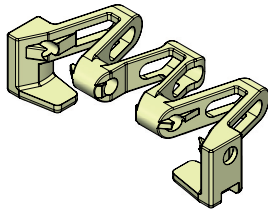

DS0200-01S55
MON-PLAIN LINK (S)
55 DUROMETER

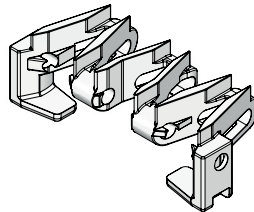

DS0200-03A
MON-6MM RAISED (A)

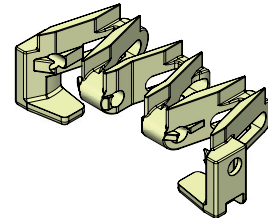

DS0200-03S55
MON-6MM RAISED (S)
55 DUROMETER

The information provided are guidelines only. This does not represent all design variations possible. For detailed or specific design requirements ,please contact a representative or email info@spantechllc.com.

MAXISPAN CHAIN

A top choice for its product cooling capabilities.

Material Options

Available in acetal and santoprene.

Versatile

With a large amount of chain types available it can be used in many different applications.

Sanitary

The open design concept improves cleanability.



SPECIFICATIONS FOR MAXISPAN CHAIN

- With a 75% open design, MaxiSpan allows liquids and debris to fall through the chain meaning less downtime due to cleaning.
- MaxiSpan also has an all plastic design making it ideal for use with metal detector sections.
- Load carrying capacity of 25 lbs/ft².
- Recommended for product cooling.

CHAIN OPTIONS:

- Plain
- Raised Top
- Moving Side Guides
- Pusher Cleats
- Pusher w/Moving Side Guide
- Santoprene High Friction

PITCH

- 50mm (1.97")

AVAILABLE WIDTH RANGE

- 209.2mm - 1209.2mm (100mm increments)
(8.24" - 47.61")
- *standard links will be machined for applicable widths

NOTES:

The information provided are guidelines only. This does not represent all design variations possible. For detailed or specific design requirements, please contact a representative or email info@spantechllc.com.

MAXISPAN CHAIN

KEY: C = CENTER • LH = LEFT HAND • RH = RIGHT HAND • MSG = MOVING SIDE GUIDE • (PU) = POLYURETHANE • (S) = SANTOPRENE
• (A) = ACETAL • (PP) = POLYPROPYLENE

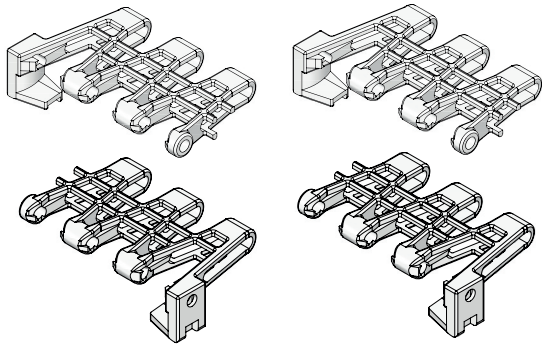

DS5210A - MAX-LH PLAIN (A)
DS5230A - MAX-RH PLAIN (A)
DS5210P - MAX-LH PLAIN (PP)
DS5230P - MAX-RH PLAIN (PP)

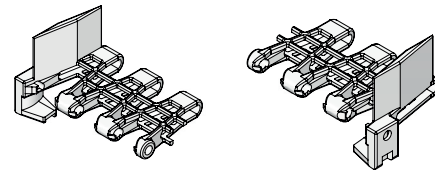

DS5218A - MAX-LH 30MM MSG (A)
DS5238A - MAX-RH 30MM MSG (A)

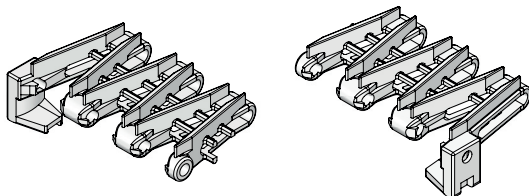

DS5212A - MAX-LH 6MM RAISED (A)
DS5232A - MAX-RH 6MM RAISED (A)

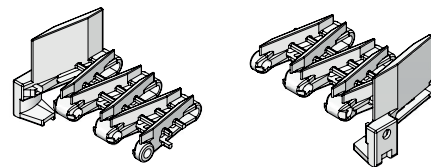

DS5220A - MAX-LH 6MM / 30MM MSG (A)
DS5240A - MAX-VRH 6MM / 30MM MSG (A)

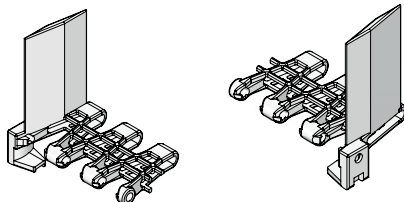

DS5214A - LH 75MM MSG (A)
DS5234A - RH 75MM MSG (A)

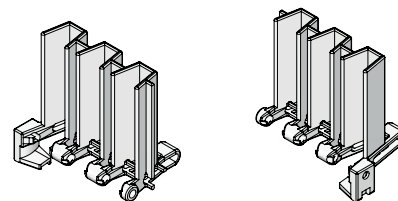

DS5222A - LH 75MM PUSHER CLEAT (A)
DS5242A - RH 75MM PUSHER CLEAT (A)

The information provided are guidelines only. This does not represent all design variations possible. For detailed or specific design requirements ,please contact a representative or email info@spantechllc.com.

MAXISPAN CHAIN

KEY: C = CENTER • LH = LEFT HAND • RH = RIGHT HAND • MSG = MOVING SIDE GUIDE • (PU) = POLYURETHANE • (S) = SANTOPRENE
 • (A) = ACETAL • (PP) = POLYPROPYLENE

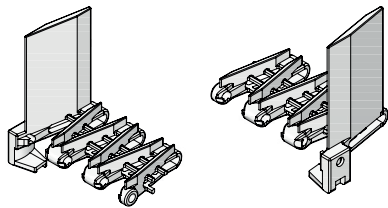

DS5216A - MAX-LH 6MM RAISED / 75MM MSG (A)
DS5236A - MAX-RH 6MM RAISED / 75MM MSG (A)

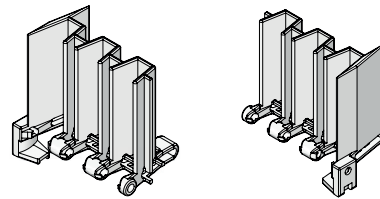

DS5224A - MAX-LH 75MM PUSHER CLEAT / MSG (A)
DS5244A - MAX-RH 75MM PUSHER CLEAT / MSG (A)

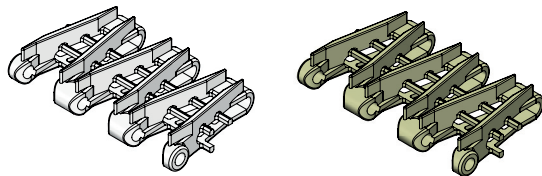

DS5203A - MAX-6MM RAISED CENTER (A)
DS5203S55 - MAX-6MM RAISED CENTER 55D (S)

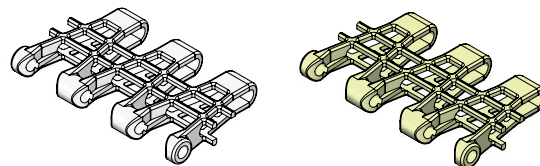

DS5201A - MAX-PLAIN CENTER (A)
DS5201P - MAX-PLAIN CENTER (PP)
DS5201S55 - MAX-PLAIN CENTER 55D (S)

The information provided are guidelines only. This does not represent all design variations possible. For detailed or specific design requirements, please contact a representative or email info@spantechllc.com.

CHAIN TYPES

[SPECIALTY CHAIN]

The information provided are guidelines only. This does not represent all design variations possible. For detailed or specific design requirements ,please contact a representative or email info@spantechllc.com.

CLOSED TOP CHAIN

Sometimes you need a conveyor chain with a smooth, closed carrying surface.

Material Options

Acetal

Safety

Smooth, closed carrying surface with no open areas offering a measure of safety perfect for operator stations.

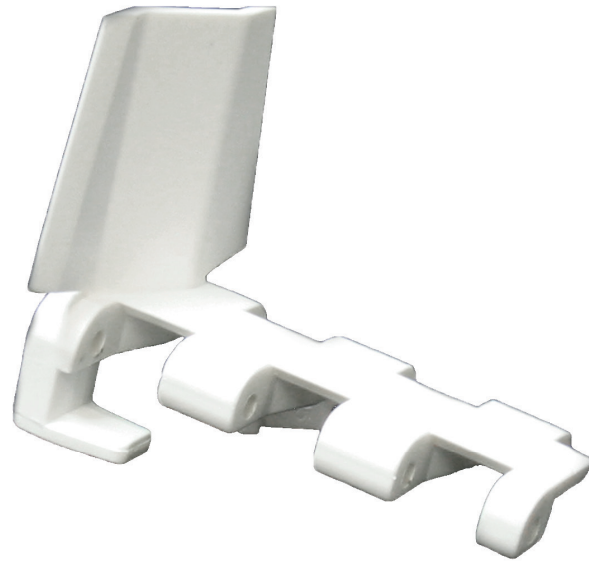

SPECIFICATIONS FOR CLOSED TOP CHAIN

- Adding internal barrel rollers to the bottom of the chain will reduce chain pull.
- Adding internal barrel rollers will limit conveyor speeds to 70 ft/min or slower.
- Horizontal bends are not permitted with this chain design.
- Capable of vertical bends.
- Works well for pack-off applications.

CHAIN OPTIONS:

- Plain
- Moving Side Guide
- Pusher Cleat
- Scoop
- Pusher w/Moving Side Guide
- Scoop w/ Moving Side Guide

PITCH

- 25mm (0.98")

AVAILABLE WIDTH RANGE

- 95.6mm - 1205.6mm (3.76" - 47.46")

NOTES:

The information provided are guidelines only. This does not represent all design variations possible. For detailed or specific design requirements, please contact a representative or email info@spantechllc.com.

CLOSED TOP CHAIN

KEY: C = CENTER • LH = LEFT HAND • RH = RIGHT HAND • MSG = MOVING SIDE GUIDE • (PU) = POLYURETHANE • (S) = SANTOPRENE
• (A) = ACETAL • (PP) = POLYPROPYLENE

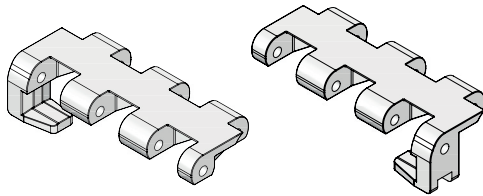

DS0063A - MCT-RH PLAIN (A)
DS0067A - MCT-LH PLAIN (A)

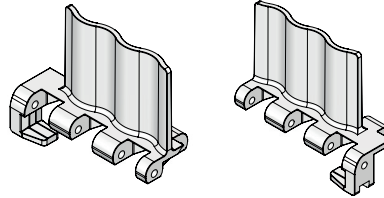

DS0068A - MCT-LH 50MM PUSHER (A)
DS0064A - MCT-RH 50 MM PUSHER (A)

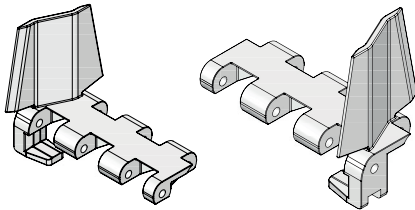

DS0069A - MCT-LH 50MM MSG (A)
DS0065A - MCT-RH 50MM MSG (A)

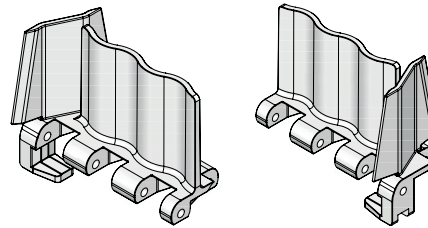

DS0070A - MCT-LH 50MM PUSHER/MSG (A)
DS0066A - MCT-RH 50MM PUSHER/MSG (A)

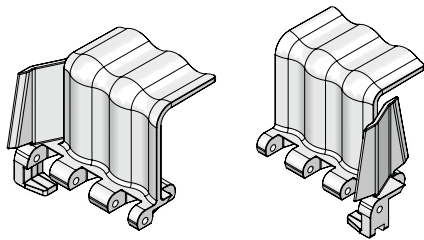

DS0057A - MCT-LH 50MM SCOOP/MSG (A)
DS0056A - MCT-RH 50MM SCOOP/MSG (A)

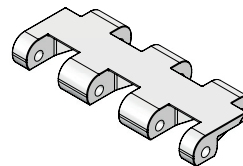

DS0061A - MCT-PLAIN CENTER (A)

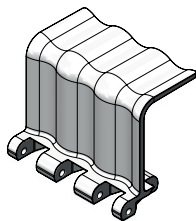

DS0058A
MCT-50MM PCENTER SCOOP (A)



DS0060A
MCT-INTERNAL BARREL ROLLER (A)

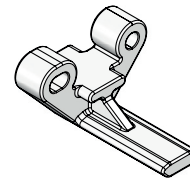

DS9964-CT-01
MCT-RETURN CHAIN SUPPORT TAB (A)

The information provided are guidelines only. This does not represent all design variations possible. For detailed or specific design requirements ,please contact a representative or email info@spantechllc.com.

MICROSPAN CHAIN

Modular chain designed to replace belt conveyor systems. End to end product movement has never been more adaptable than with MicroSpan Chain components and transfers.

Material Options

Acetal

Simple Repairs

MicroSpan chain has a snap-fit design making section replacements easy and simple.

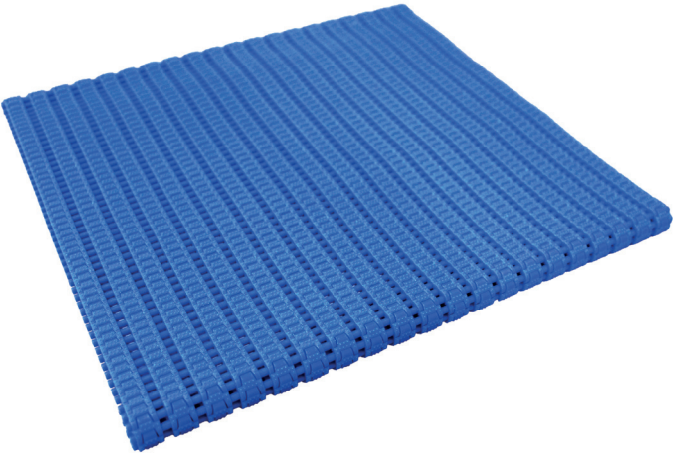

Part Numbers

300 MM WIDTH

DA6600-2030-BLUE	4MM PLAIN BLUE
DA6600-2050-BLUE	6MM PLAIN BLUE
DA6600-2040-BLUE	4MM RAISED BLUE
DA6600-2060-BLUE	6MM RAISED BLUE
DA6600-2060HF-BLUE	6MM HIGH FRICTION BLUE

UNDER 300 MM WIDTH (XX = WIDTH<300MM) SEE CHART

DA6600-2030-BLUE-XX	4MM PLAIN BLUE
DA6600-2050-BLUE-XX	6MM PLAIN BLUE
DA6600-2040-BLUE-XX	4MM RAISED BLUE
DA6600-2060-BLUE-XX	6MM RAISED BLUE
DA6600-2060HF-BLUE-XX	6MM HIGH FRICTION BLUE

SPECIFICATIONS FOR MICROSPAN CHAIN

- Typically used on transfers and EZSpan conveyors.
- Max load and torque is based off the chain width and speed.
- Capable of transferring around a 6mm nose bar.
- 6mm high friction chain option is available for inclining product.
- High friction option has a Santoprene insert.

CHAIN OPTIONS:

- 4mm & 6mm Plain
- Raised
- 6mm Raised High Friction

PITCH

- 5mm

AVAILABLE WIDTH RANGE

- 300mm (11.81") standard width. Can be cut to smaller widths or multiple chains for wider widths. (15mm increments)

NOTES:

The information provided are guidelines only. This does not represent all design variations possible. For detailed or specific design requirements, please contact a representative or email info@spantechllc.com.

MICROSPAN CHAIN

KEY: C = CENTER • LH = LEFT HAND • RH = RIGHT HAND • MSG = MOVING SIDE GUIDE • (PU) = POLYURETHANE • (S) = SANTOPRENE
• (A) = ACETAL • (PP) = POLYPROPYLENE

MicroSpan
Chain Width

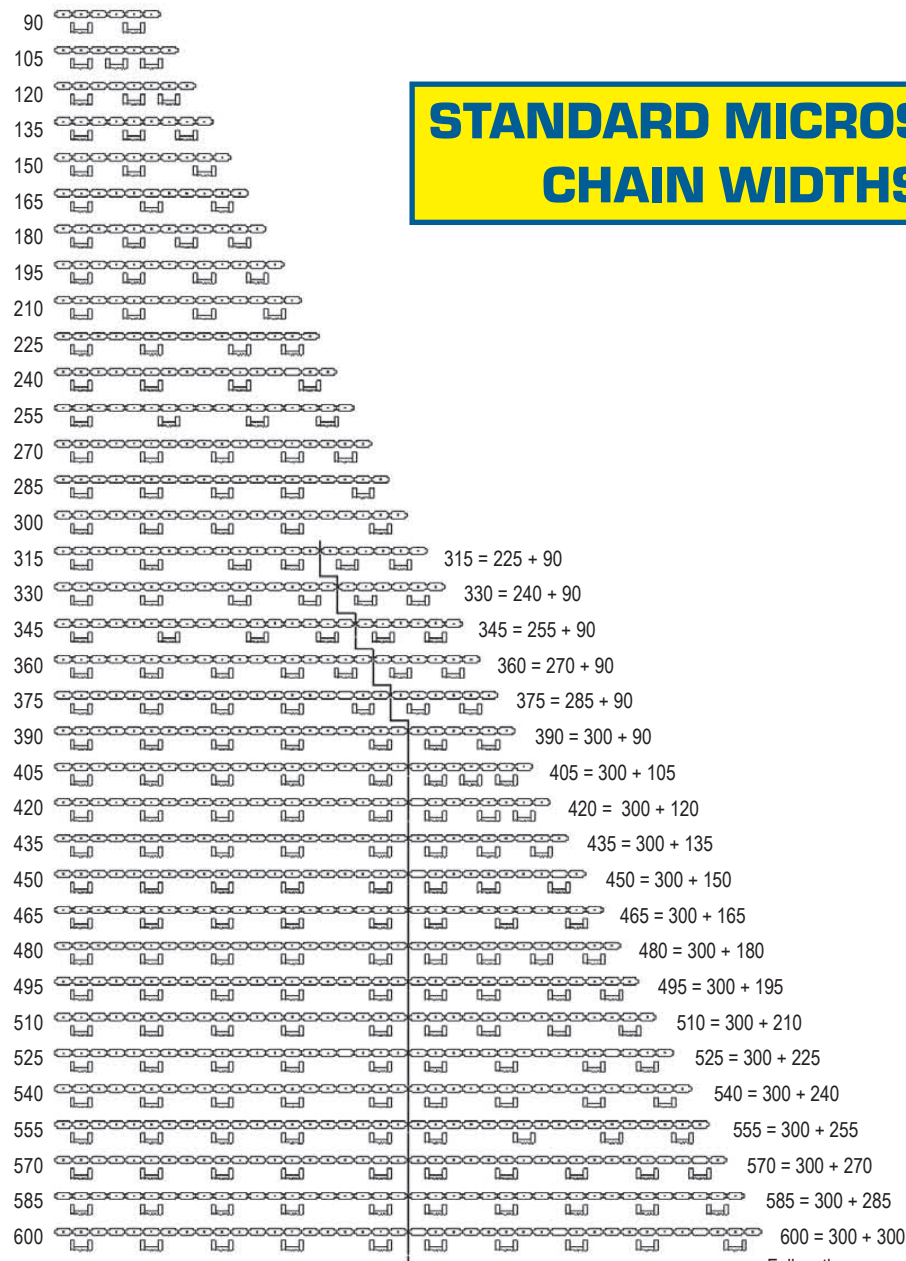

STANDARD MICROSPAN CHAIN WIDTHS

Follow the same pattern as
above for larger chain widths.

The information provided are guidelines only. This does not represent all design variations possible. For detailed or specific design requirements ,please contact a representative or email info@spantechllc.com.

MINILINK CHAIN

Ideal choice to move small products.

Material Options

Acetal

Convergence / Divergence

Can converge product to smaller or larger lane centers for loading, packaging equipment.

Easy to Integrate

The compact cross-section means it can fit easily into processing and packaging equipment where other conveyors cannot.



SPECIFICATIONS FOR MINILINK CHAIN

- MiniLink chain uses stainless steel rods.
- Works well for transporting small products.
- Horizontal curves and elevation changes are possible within a single conveyor system.
- Multiple lanes of MiniLink can be used to perform a merge function, and several lanes of product can be merged into a single lane without transfer.
- Applications include: merging, spreading, converging, loading and diverting.

CHAIN OPTIONS:

- Plain

PITCH

- 25mm (0.98")

AVAILABLE WIDTH RANGE

- 30mm or 60mm

NOTES:

The information provided are guidelines only. This does not represent all design variations possible. For detailed or specific design requirements, please contact a representative or email info@spantechllc.com.

MINILINK CHAIN

KEY: C = CENTER • LH = LEFT HAND • RH = RIGHT HAND • MSG = MOVING SIDE GUIDE • (PU) = POLYURETHANE • (S) = SANTOPRENE
• (A) = ACETAL • (PP) = POLYPROPYLENE

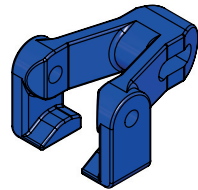

DS8010-30-06
MIN-30MM PLAIN (A)

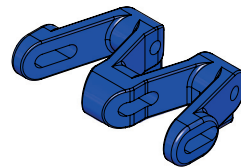

DS8010-60-06
MIN-60MM PLAIN (A)

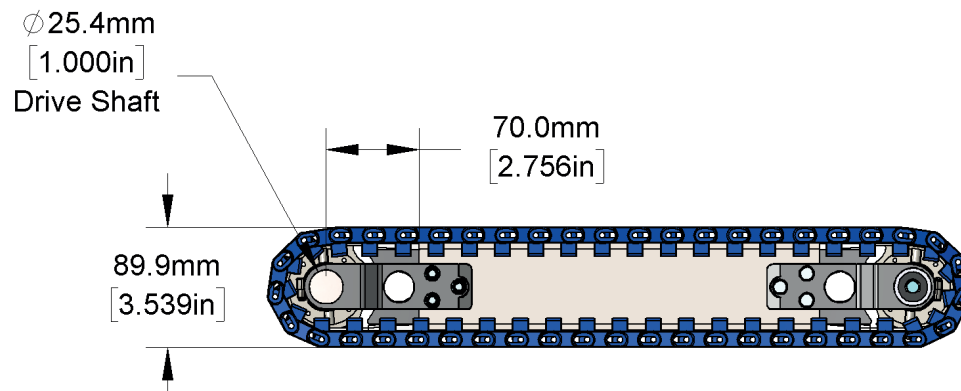
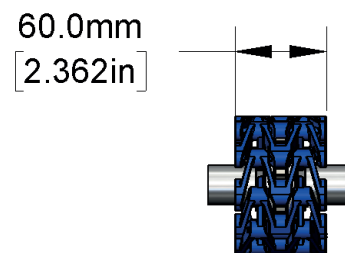
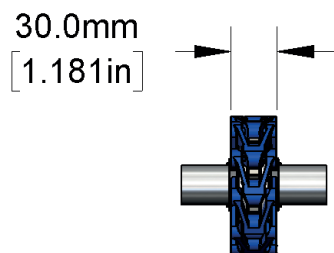

The information provided are guidelines only. This does not represent all design variations possible. For detailed or specific design requirements ,please contact a representative or email info@spantechllc.com.

J-TRAX CHAIN

The smarter way to move food products.

Material Options

Acetal chain link and stainless steel rod

Simple Repairs

Very simple design with minimal parts allows for fast and easy repairs.

Durable

No wire-to-wire friction means no metal fatigue.

Sanitary

Fully washdown rated with stainless steel that is easy to clean and sanitize.

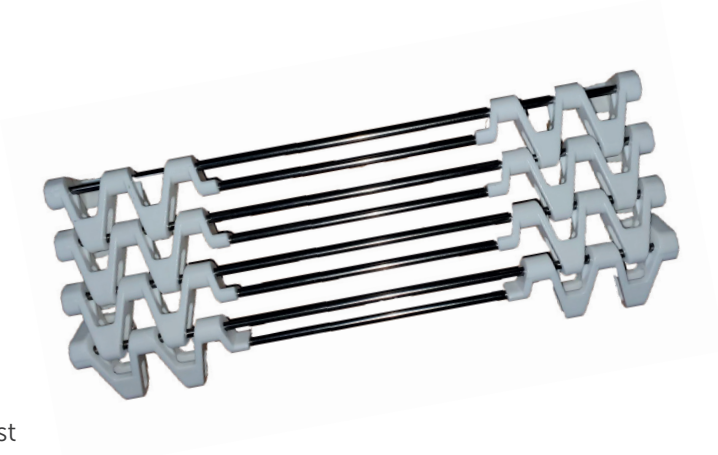

SPECIFICATIONS FOR J-TRAX CHAIN

- J-Trax has an open rod design making it ideal for the food industry.
- Applicable for: cooling, breading & battering, enrobing, depositing, draining/dewatering, drying and also general conveyance.
- Open rods facilitate rapid cooling of bakery items and let debris fall through rather than build up.
- 4mm diameter stainless steel rod with a 12mm pitch.

CHAIN OPTIONS:

- Plain

PITCH

- 25mm w/ 12mm intermittent rod

AVAILABLE WIDTH RANGE

- 155.6mm - 1205.6mm (6.13" - 47.46")

NOTES:

The information provided are guidelines only. This does not represent all design variations possible. For detailed or specific design requirements, please contact a representative or email info@spantechllc.com.

J-TRAX CHAIN

KEY: C = CENTER • LH = LEFT HAND • RH = RIGHT HAND • MSG = MOVING SIDE GUIDE • (PU) = POLYURETHANE • (S) = SANTOPRENE
• (A) = ACETAL • (PP) = POLYPROPYLENE

JTRAX CHAIN ROD

REFER TO CHAIN ROD SECTION FOR
SPECIFIC CHAIN ROD LENGTHS AND TYPES

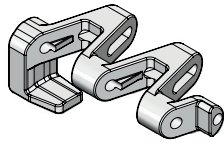

DS0155-02A
MJT-LEFT HAND JTRAX (A)

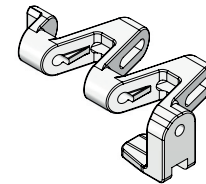

DS0156-02A
MJT-RIGHT HAND JTRAX (A)

The information provided are guidelines only. This does not represent all design variations possible. For detailed or specific design requirements ,please contact a representative or email info@spantechllc.com.



CONVEYORS

[DIRECTIONAL SECTIONS]

The information provided are guidelines only. This does not represent all design variations possible. For detailed or specific design requirements, please contact a representative or email info@spantechllc.com.

BED SECTIONS

Span Tech conveyors are manufactured with either stainless steel, powder coated or aluminum framing. Standard bed sections are 12 ft. in length with a crossbar every 24.0". Higher load applications use crossbars every 12.0" for more chain support. Individual bed sections are bolted together with an 8 hole pattern connecting strap.

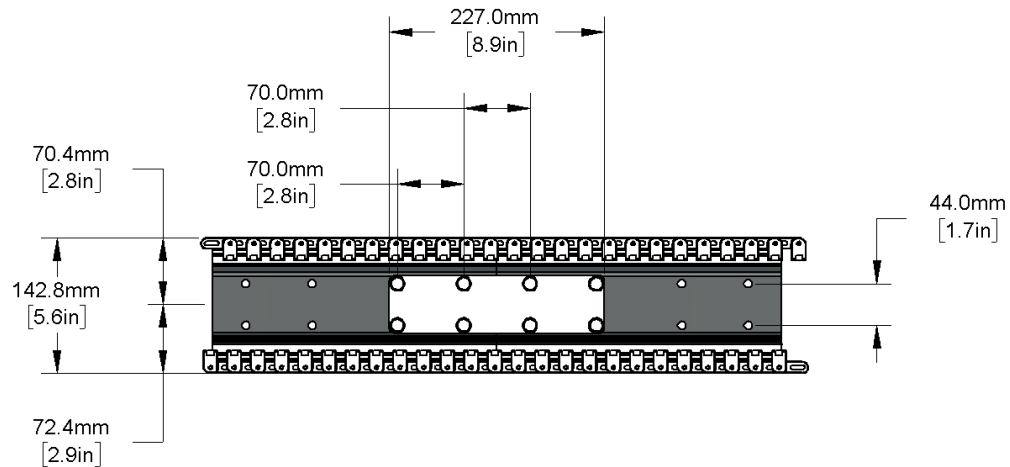

The illustration above is an elevation view of a conveyor bed section. Typical location dimensions are given for crossbar spacing as well as connecting strap hole locations. The overall bed section depth has also been noted, which applies to plain chain only. For raised top or cleated chain add 2 times the cleat height to the standard bed section depth.

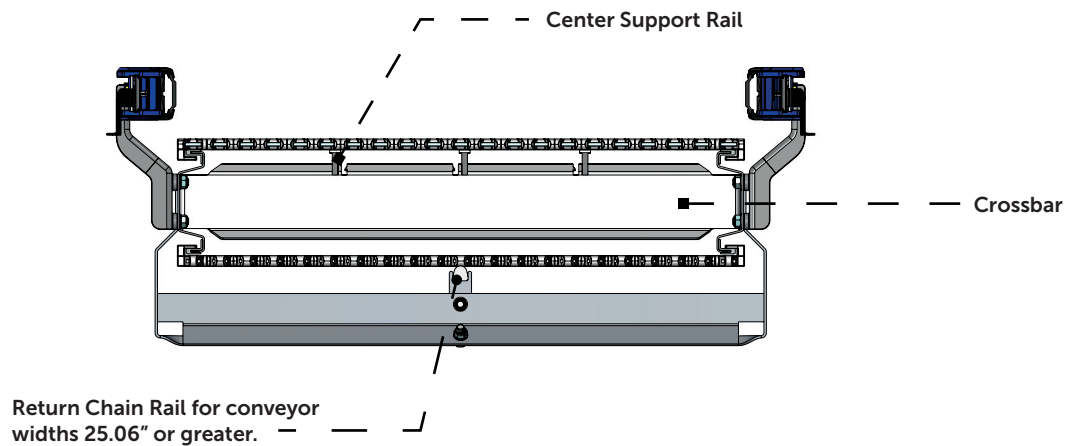

The illustration above represents a cross section view of a standard conveyor bed section with guide rails, center support rails, and return chain support rail.

The information provided are guidelines only. This does not represent all design variations possible. For detailed or specific design requirements, please contact a representative or email info@spantechllc.com.

HORIZONTAL CURVES

One of the most unique features of Span Tech's family of conveyors is the horizontal curve. Horizontal curves can be manufactured to any degree angle at any radius staying within the design requirements. When designing conveyors that incorporate horizontal curves, be certain to apply the following rules of thumb.

👍 Between offsetting Horizontal Curves (S-curves) there should be a straight section that is greater than or equal to 2 times the chain width. This applies to all conveyors within the Span Tech family.

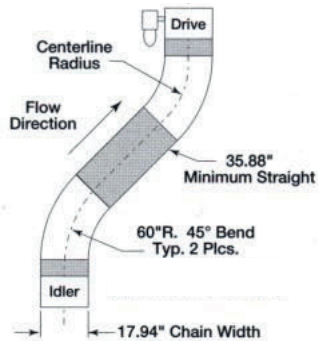

The illustration above shows the placement of straight sections between offsetting curves for a MultiSpan conveyor.

The following rule applies to all 25mm chain.

👍 From the end of a Horizontal Curve to the end of a drive or idler, there should be a straight section with a length that is greater than or equal to the chain width.

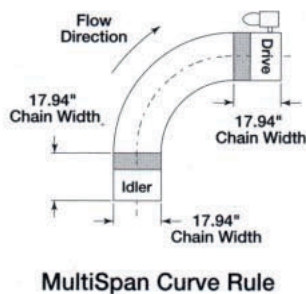

The following rule applies to all 50mm chain.

👍 From the end of a Horizontal Curve to the end of a drive or idler, there should be a straight section with a length that is greater than or equal to 2 times the chain width.

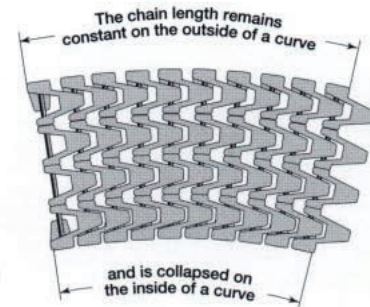
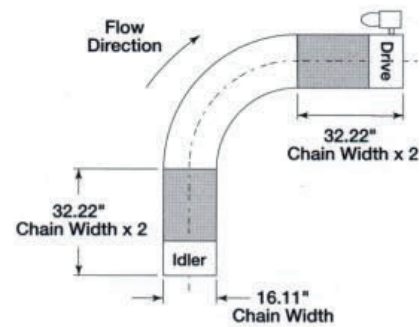

Chain condition while traveling through a horizontal curve

The reason for following the previous rules when applying horizontal curves in a conveyor layout is illustrated above. The pitch length of the chain is constant on the outside radius of a curve and is collapsed on the inside radius of a curve. The chain must have time for the rods to straighten out allowing the chain stress to be redistributed evenly before making another direction change along the conveyor path.

The information provided are guidelines only. This does not represent all design variations possible. For detailed or specific design requirements, please contact a representative or email info@spantechllc.com.

CALCULATING MINIMUM CENTERLINE RADIUS FOR ALL SPAN TECH CONVEYORS

MULTISPAN

Chain Width^{inches} x 3.12

Chain Width^{mm} x 3.12

MAXISPAN

Chain Width^{inches} x 3.48 - 6.91"

Chain Width^{mm} x 3.48 - 175.5mm

25MM SUPERTIGHT

Chain Width^{inches} x 2.29 - 2.64"

Chain Width^{mm} x 2.29 - 67.06mm

50MM SUPERTIGHT

Chain Width^{inches} x 1.93

Chain Width^{mm} x 1.93

***The absolute minimum centerline turning radius for any of Span
Tech conveyors is 18.0" (457.20mm) for aluminum framing and
21.0" (533.40mm) for steel framing.***

VERTICAL BENDS

Elevation changes in a conveyor layout can be accomplished in various ways but the most common method is with the use of vertical bends.

The Span Tech family of conveyors uses molded plastic vertical bends made of high density polypropylene.

Vertical bends have a centerline radius of 15.75" (400mm) and range from 4° to 90° angles in increments of 1°.

Use the following rules of thumb when designing conveyor layouts that include vertical bends for making elevation changes.

👍 Drive or Idler assemblies can be attached directly to a vertical bend assembly.

Incline Angle	Rise in Ft./Inches	Rise in Ft./MM	Incline Angle	Rise in Ft./Inches	Rise in Ft./MM	Incline Angle	Rise in Ft./Inches	Rise in Ft./MM
1°	0.209	5.32	21°	4.606	117.00	41°	10.431	264.96
2°	0.419	10.64	22°	4.848	123.15	42°	10.805	274.44
3°	0.629	15.97	23°	5.094	129.38	43°	11.190	284.23
4°	0.839	21.31	24°	5.343	135.71	44°	11.588	294.34
5°	1.050	26.67	25°	5.596	142.13	45°	12.000	304.80
6°	1.261	32.04	26°	5.853	148.66	46°	12.426	315.63
7°	1.473	37.42	27°	6.114	155.30	47°	12.868	326.86
8°	1.686	42.84	28°	6.381	162.07	48°	13.327	338.51
9°	1.901	48.28	29°	6.652	168.95	49°	13.804	350.63
10°	2.116	53.74	30°	6.928	175.98	50°	14.301	363.25
11°	2.333	59.25	31°	7.210	183.14	51°	14.819	376.40
12°	2.551	64.79	32°	7.498	190.46	52°	15.359	390.13
13°	2.770	70.37	33°	7.793	197.94	53°	15.925	404.48
14°	2.992	76.00	34°	8.094	205.59	54°	16.517	419.52
15°	3.215	81.67	35°	8.402	213.42	55°	17.138	435.30
16°	3.441	87.40	36°	8.719	221.45	56°	17.791	451.88
17°	3.669	93.19	37°	9.043	229.68	57°	18.478	469.35
18°	3.899	99.04	38°	9.375	238.14	58°	19.204	487.78
19°	4.132	104.95	39°	9.717	246.82	59°	19.971	507.27

Shown above is the rise per foot for elevation changes at various angles.

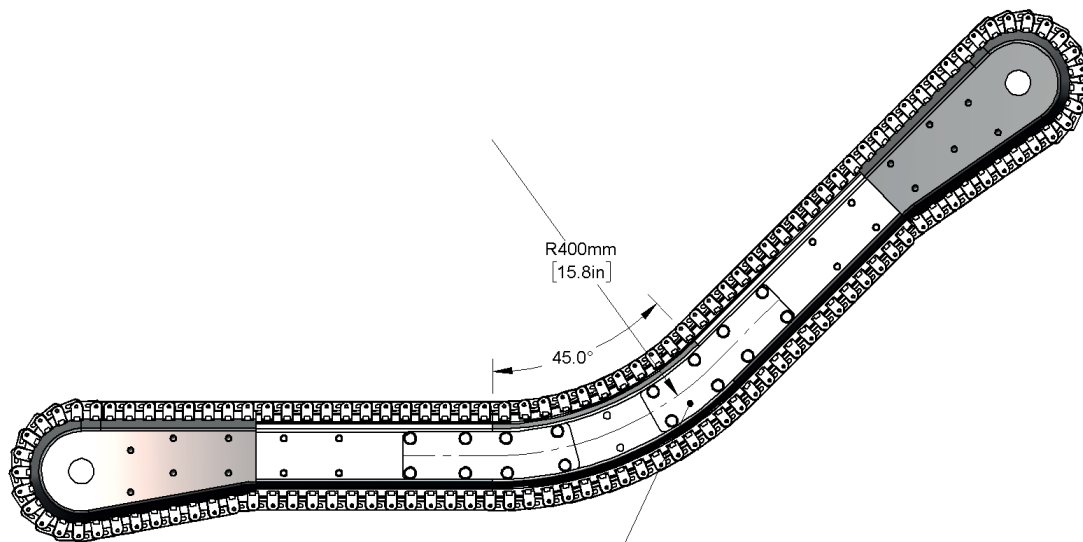

2° - 30° vertical bends have (1) connecting strap per conveyor side.
 > 30° vertical bends have two (2) connecting straps per side.

The information provided are guidelines only. This does not represent all design variations possible. For detailed or specific design requirements, please contact a representative or email info@spantechllc.com.

SUPPORT STRUCTURES

Standard Supports [1]

Span Tech standard stainless steel or painted mild steel supports are 2" x 2" tubing, with a 1" x 1" horizontal cross brace.

 **Standard support elevations are 12" - 84" Top of Conveyor.**

Drive Supports [2]

Drive supports include an additional extended bottom brace to help stabilize the drive end of the conveyor.

Aluminum Supports [3]

Aluminum Supports are "C" channel.

Support Feet Options [4]

Each support comes with optional feet types.

- Free Standing or Bolted to the floor. [4a]
- Lockable swivel casters. [4b]

Ceiling Support Options [5]

Ceiling support brackets are used for all elevations over 84" Top of Conveyor unless specified by the customer (at which the job becomes a special design).

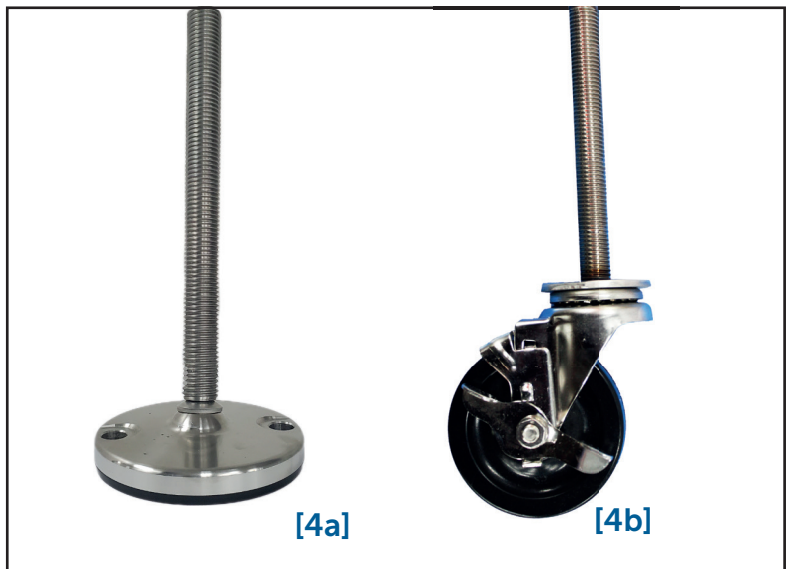
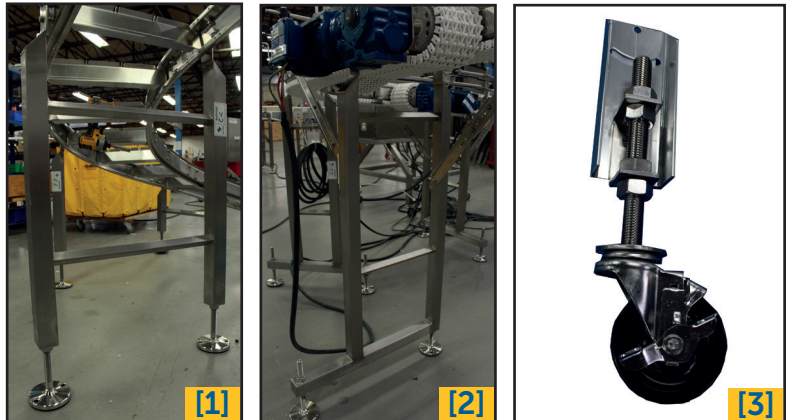

The information provided are guidelines only. This does not represent all design variations possible. For detailed or specific design requirements ,please contact a representative or email info@spantechllc.com.

CONVEYORS **[ELEVATION CHANGE]**

The information provided are guidelines only. This does not represent all design variations possible. For detailed or specific design requirements ,please contact a representative or email info@spantechllc.com.

TOPPER LIFT

Tackle tricky angles, product orientation, and elevation change with a smaller footprint. The Topper Lift puts steep angles within your reach.

Product Handling

The Topper Lift is capable of handling rigid or flexible products such as bagged, boxed, or frozen items.

Impressive Elevation

Most cost effective for elevating up to 60°

No PLC? No Problem

No programmable logic controller (PLC) is needed to run the Topper Lift.

Configurable Width

Using our standard chain widths, the Topper Lift's width can be configured to fit your needs and footprint.



RULES OF THUMB FOR TOPPER LIFTS

MAX RECOMMENDED ANGLE: 60°
MAX RECOMMENDED SPEED: 200 fpm
PRODUCT PITCH = 4 * PRODUCT LENGTH

- The Topper Lift conveyor system sandwiches a product between two conveyor chains in order to apply pressure across the top of the product and prevent it from tipping over. This allows the product to be transported at excessive angles that would not be possible on a standard incline conveyor.
- There must be (3) product lengths between adjacent products.
- Chain width must be at least 4.94" wider than the product in order to guarantee full high friction module coverage.
- There must be at least 12" of vertical clearance above the top of the product.
- Multiple lanes of product are not recommended.
- For products that are taller than they are long, tipping of product may occur.

NOTES:

The information provided are guidelines only. This does not represent all design variations possible. For detailed or specific design requirements, please contact a representative or email info@spantechllc.com.

OUTRUNNER SPIRAL

A cost effective solution for changing elevations. Gives you the capacity to move a wide range of product types without taking up valuable floor space.



Small Footprint

Save floor space by elevating with an Outrunner Spiral.

Extremely Configurable

A variable height, diameter, angle, chain width, infeed, and exit location.

Applications Include

Elevating, cooling, curing, and dwell times.

Catenary Free

Our chain is captured throughout the entire system making the Outrunner Spiral safer than other spirals.

RULES OF THUMB FOR OUTRUNNER SPIRALS

MAX INCLINE ANGLE: 25°

MAX DECLINE ANGLE: 4°

MINIMUM TIER PITCH: 4.92" (125mm)

MAX SPEED LIMITS BASED ON CHAIN WIDTH:

3.76" - 7.31" = 250 fpm (95.5mm - 185.7mm)

8.49" - 12.03" = 200 fpm (215.6mm - 305.6mm)

13.21" - 17.94" = 175 fpm (335.5mm - 455.7mm)

19.11" - 23.84" = 150 fpm (485.4mm - 605.5mm)

- All Outrunner Spirals must have a controlled stop/start sequence (smooth acceleration/deceleration) to prevent chain from crowding into the Outrunner Drive sprocket.

- All Outrunner Spirals must be designed with Pillow Top or SuperTight 6mm or 30mm moving side guides on the sides where it is driven by the Outrunner sprockets. In addition, the opposite side of the chain should also be supplied with a moving side guide unless a side by side transfer is required.

- Outrunner Spirals are intended to add dwell time to a product flow, but are not intended to be accumulation devices (holding product while the spiral runs).

- Outrunner Spirals will NOT maintain product orientation.

- A torque limiter between the gearmotor and the primary sprocket is required and this torque limiter must have an accompanying proximity sensor to tell the PLC or VFD to stop the spiral in case of an over-torque condition.

NOTES:

The information provided are guidelines only. This does not represent all design variations possible. For detailed or specific design requirements, please contact a representative or email info@spantechllc.com.

HELICAL CURVE

Our Helical Curve makes simultaneous direction and elevation change a breeze.

Industry Leader

The Helical Curve has the most aggressive elevation change to curve radius in the industry.

Top-Notch Turning Radius

Offers the tightest turning radius in the industry that others cannot provide.

Incline / Decline

Versatility with inclining and declining.

Catenary Free

Chain is captured throughout the entire system which makes the Helical Curve safer than the competition.



RULES OF THUMB FOR HELICAL CURVES

- MAXIMUM ANGLE: 20°
- 7° and above requires a larger centerline radius.
- Above 10° add the following extra length to the already existing 12" bed section adjacent to the Helical Curve.
 - 5.5" for opposing curves
 - 2.75" for a single curve

NOTES:

The information provided are guidelines only. This does not represent all design variations possible. For detailed or specific design requirements, please contact a representative or email info@spantechllc.com.

WEDGE UNIT

The Wedge Unit provides vertical movement in a compact and all mechanical design for ultimate reliability.

Small Footprint

The Wedge Unit has an extremely small footprint compared to elevation change.

Technology Not Required

No expensive controls are needed to operate the Wedge Unit.

Handles Most Rigid Products

Available in a wide variety of chain types and widths to accommodate a large array of products.

Version Options

You have the choice of a positionable or fully adjustable unit.



RULES OF THUMB FOR WEDGE UNITS

MAX SPEED:

180 feet per minute. (55 mpm)

MINIMUM INFEED ELEVATION: 26 inches

OVERALL WIDTH:

39.1" - positionable units

48.4" - 0 - 12" adjustable units

60.4" - 0 - 24" adjustable units

- Wedge conveyors must be equipped with a variable frequency drive (VFD) with soft start/stop capability. The VFD can be customer supplied or provided by Span Tech.

- If your incoming product does not meet the minimum gap requirements, you may increase the velocity of the Wedge Unit to pull the needed gap. Use the basic formula below to find the necessary velocity of the Wedge Unit.

$$V_w = V_o (L + Gap_{min} / L + Gap_i)$$

V_w = Desired velocity of Wedge unit (FPM)

V_o = Initial velocity of incoming conveyor (FPM)

Gap_{min} = minimum gap required

Gap_i = initial product gap

STANDARD CHAIN WIDTHS / CENTER LINE RADIUS :

6.13 inches - 21"

7.31 inches - 22.81"

8.49 inches - 26.49"

9.67 inches - 30.45"

10.85 inches - 33.85"

RECOMMENDED PRODUCT HEIGHT RESTRICTIONS:

6.13" - 2.0" - 6.9"

7.31" - 7.0" - 11.9"

8.49" - 12.0" - 16.9"

9.67" - 17.0" - 21.9"

10.85" - 22.0" - 24.0"

- The spacing between products (gap) is critical to the layout of the Wedge Unit. If the gap is too small, products could contact and interfere with each other through the curves. Use the following formula to determine the minimum gap for your product.

$$Gap_{min} = (L+1) / (2R/H) - 1$$

R =Radius of Curve (referenced above),

H =Height of product,

L =Length of product,

Gap_{min} =Minimum gap required for your product

The information provided are guidelines only. This does not represent all design variations possible. For detailed or specific design requirements, please contact a representative or email info@spantechllc.com.

WEDGE UNIT [CONTINUED]

DYNAMIC TOTAL LOAD CAPACITY:

• 10' OFFSET

Chain Width	50 FPM	100 FPM	150 FPM	180 FPM
6.13"	92lbs	40lbs	22lbs	27lbs
7.31"	92lbs	38lbs	20lbs	24lbs
8.49"	92lbs	37lbs	19lbs	21lbs
9.67"	92lbs	36lbs	17lbs	18lbs
10.85"	91lbs	34lbs	15lbs	15lbs

• 20' OFFSET

Chain Width	50 FPM	100 FPM	150 FPM	180 FPM
6.13"	146lbs	62lbs	35lbs	25lbs
7.31"	145lbs	60lbs	32lbs	22lbs
8.49"	143lbs	58lbs	29lbs	19lbs
9.67"	142lbs	55lbs	26lbs	17lbs
10.85"	140lbs	52lbs	23lbs	15lbs

• 30' OFFSET

Chain Width	50 FPM	100 FPM	150 FPM	180 FPM
6.13"	181lbs	85lbs	47lbs	34lbs
7.31"	176lbs	82lbs	43lbs	31lbs
8.49"	170lbs	78lbs	39lbs	26lbs
9.67"	164lbs	74lbs	35lbs	22lbs
10.85"	159lbs	71lbs	31lbs	18lbs

NOTES:

The information provided are guidelines only. This does not represent all design variations possible. For detailed or specific design requirements, please contact a representative or email info@spantechllc.com.

CONVEYORS

[DIVERTING & MERGING]

The information provided are guidelines only. This does not represent all design variations possible. For detailed or specific design requirements ,please contact a representative or email info@spantechllc.com.

POWERED DIVERT

Prevent stalling issues with a Powered Divert, an ideal solution for most products.

Adjustable

Manually or pneumatically adjusted.

Power Forward

Helps product continue moving forward which prevents stalling issues.

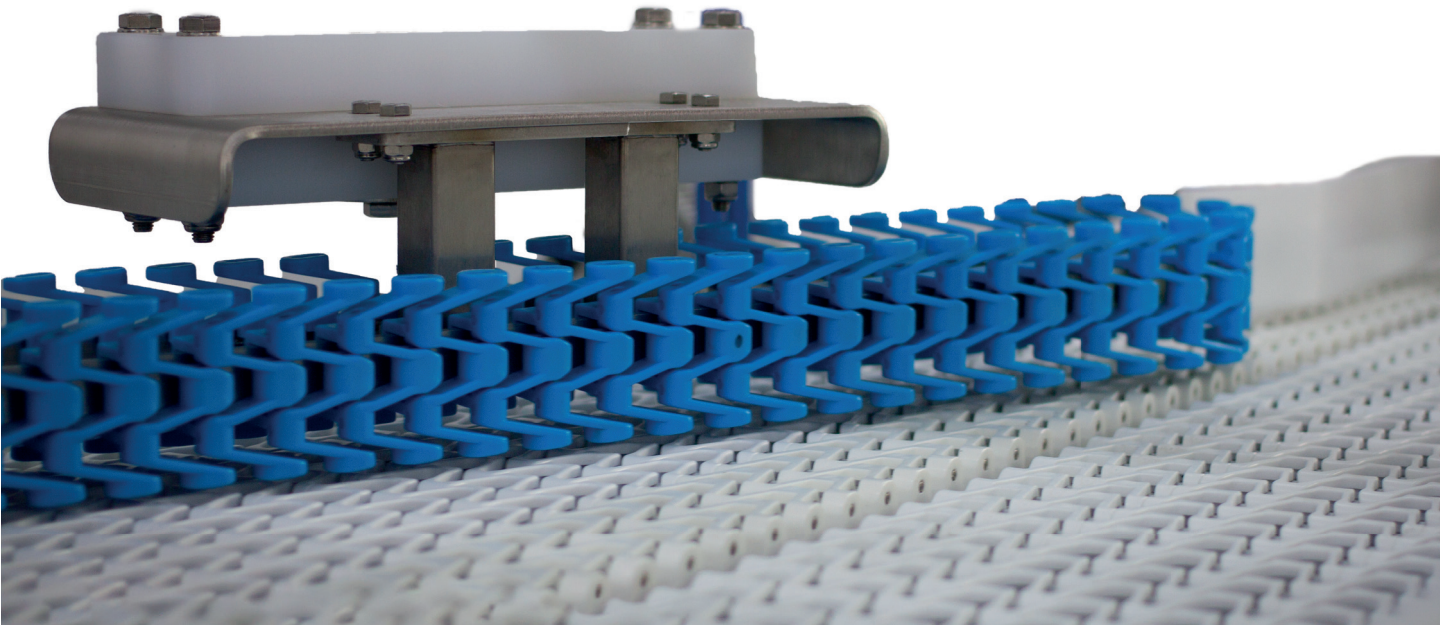

RULES OF THUMB FOR POWERED DIVERTS

- Products can be rigid or flexible to use the Powered Divert.
- Products must be large enough so as not to fall between the two parallel conveyors.
- Comes in two options: manual adjusting or pneumatic adjusting.
- Helps maintain orientation & eliminates friction/ rubbing associated with static divert rails.

NOTES:

The information provided are guidelines only. This does not represent all design variations possible. For detailed or specific design requirements, please contact a representative or email info@spantechllc.com.

TRANSPOSITOR

Successfully creates right-angle product transfers without skewing.

Product Handling

Has the ability to handle almost any type of product.

Low Maintenance

No lubrication is required to run, making it virtually maintenance free.

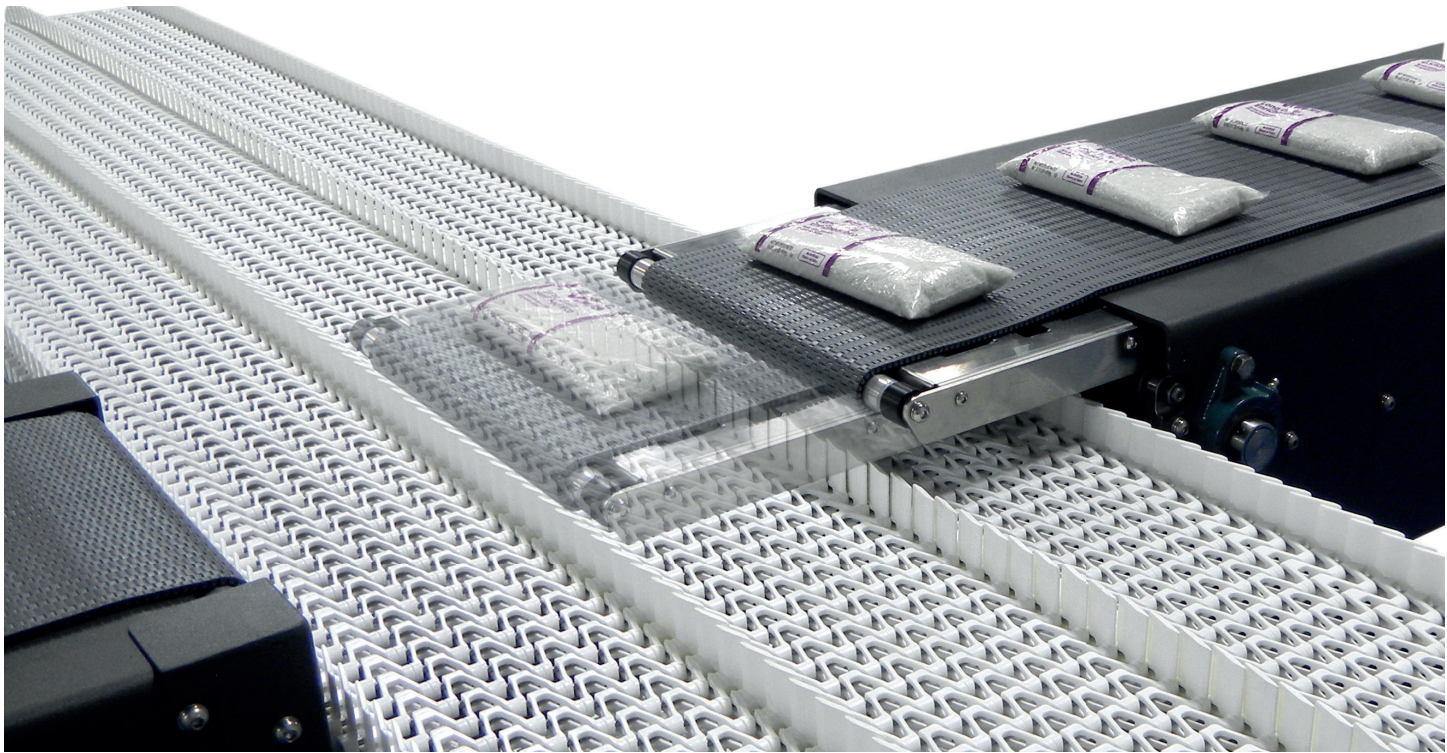

RULES OF THUMB FOR TRANSPOSITORS

- Transpositors can be used as a product reject or divert.
- Ideal for feeding wrappers, casepackers, and handpack stations.
- Sprocket driven chain.
- Build product lanes or patterns across the width of receiving conveyors.
- Widths can be up to 600mm wide.
- Available cross belts for side to side diverts.

NOTES:

The information provided are guidelines only. This does not represent all design variations possible. For detailed or specific design requirements ,please contact a representative or email info@spantechllc.com.

VERTICAL SWITCH

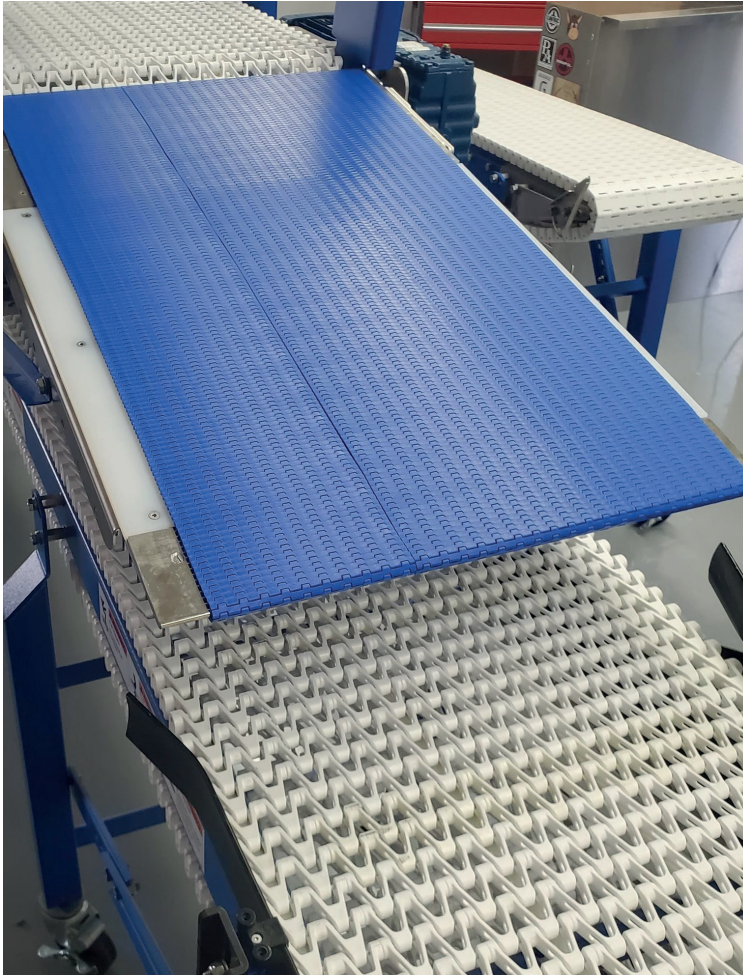

The Vertical Switch can be designed to divide flow between two elevations or if needed as a product reject.

Elevation Options

Allows product to be discharged at multiple elevations. Can be used as a reject system.

Cleanability

Built for washdown applications.

Versatile

Can be designed with MicroSpan technology or standard conveyor design.

RULES OF THUMB FOR VERTICAL SWITCHES

- Can be used to divert flow or merge flow.
- Typically slave driven off of discharge conveyor. Can be independently driven.
- Can be designed with custom lengths.
- Can be used in decline or incline applications.
- Can be used as a reject system.

NOTES:

The information provided are guidelines only. This does not represent all design variations possible. For detailed or specific design requirements, please contact a representative or email info@spantechllc.com.

PUSHERS & SQUEEZE STOPS

Pusher Stations sort your products efficiently by ejecting them or halting them altogether.

Heavy Duty

Construction is suitable for very heavy products.

Design Options

Available in pneumatic cylinder or electric motor.

Application Options

Options include: diverting, palletizing, or rejecting.



RULES OF THUMB FOR PUSHERS & SQUEEZE STOPS

- Conveyor cannot have a moving side guide unless the entire chain is raised, and even then the conveyor is limited to 6mm raised.
- A minimum gap is usually required for a Pusher Station and is necessary to give the pusher mechanism time to retract, so it does not collide with the next product. Sometimes certain products can be pushed in accumulation.
- Additional bed section crossbars are used at pusher location.

NOTES:

The information provided are guidelines only. This does not represent all design variations possible. For detailed or specific design requirements ,please contact a representative or email info@spantechllc.com.

HIGH SPEED SWITCH

The High Speed Switch divides your product flow effectively, quickly, and reliably.



Fast

Switch up to 300 parts per minute.

Reliable

Virtually crash proof with the patented toggle system design.

Very Configurable

Lots of configuration options: 1:2, 1:3, 1:4, 2:4.

Low Maintenance

The High Speed Switch is rated for continuous 24 hour per day operation.

RULES OF THUMB FOR HIGH SPEED SWITCHES

MAX SPEED: 350 feet per minute.

MAXIMUM CARRIER ROD LENGTH: 48 inches

MINIMUM PRODUCT LENGTH (DIAMETER): 4 inches

MINIMUM CARRIER OFFSET: 1:3 or greater = 4.75 inches

- There must be 4 inches of gap between successive products.
- Can be built with lexan guarding for even greater safety.
- Uses coated steel rods or anodized aluminum rods.
- High Speed Switches will not run in reverse direction.

NOTES:

The information provided are guidelines only. This does not represent all design variations possible. For detailed or specific design requirements, please contact a representative or email info@spantechllc.com.

CONVEYORS

[SPECIALTY]

The information provided are guidelines only. This does not represent all design variations possible. For detailed or specific design requirements ,please contact a representative or email info@spantechllc.com.

EZSPAN CONVEYOR

EZSpan uses extremely thin, modular plastic chain giving you several advantages over typical belt conveyors.

No Tracking Issues

Uses sprocket driven modular plastic chain (not fabric belt) eliminating any tracking issues.

Constant End to End Distance

No take-up units at the ends of the conveyor, meaning the length you order is the length you get.

No Integration Problems

The thinnest standard belt conveyor made, making it very easy to integrate with other machinery.

Hassle Free Maintenance

The drive unit has been designed for increased performance and to make maintenance easy.



RULES OF THUMB FOR EZSPAN CONVEYORS

- 300mm MicroSpan plain or raised chain.
- 2.4' - 30' lengths available.
- VFD INCLUDED W/ AVAILABLE OPTIONS 120/240 VAC (1p) or 240 VAC (3p).
- SPEED RANGE - 30 - 110 fpm.
- Optional supports beginning at conveyor lengths of 3.2' or longer.
- 29" - 45" support elevations.
- 34" - 50" caster support elevation.
- Optional adjustable guide rails.
- Optional low profile nose bar ends. (18mm OD of chain)
- Non-washdown.

NOTES:

The information provided are guidelines only. This does not represent all design variations possible. For detailed or specific design requirements, please contact a representative or email info@spantechllc.com.

TWIST CONVEYOR

The Twist conveyor takes full advantage of the no catenary design making up to 90° twists possible.

Rotation

Capable of rotating products 90° in only 60 linear inches.

Product Orientation

Reorients the product with no additional automation and no disruption in conveyance.

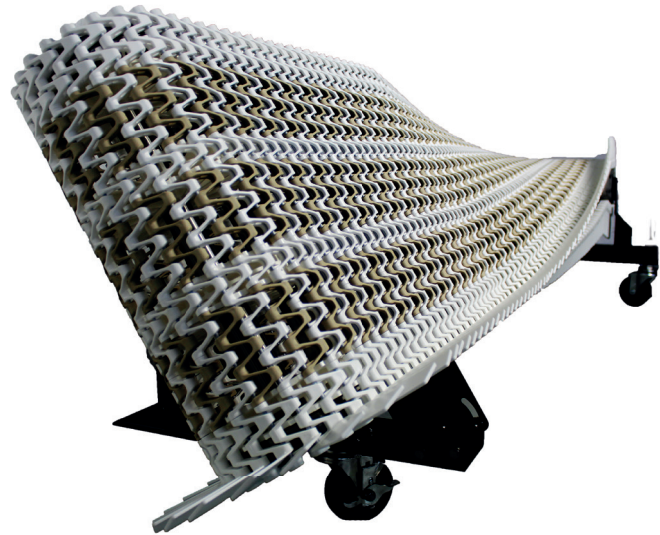

RULES OF THUMB FOR TWIST CONVEYORS

- 60 Rods = 90° of twist
- Reorients the product with no additional automation and no disruption in conveyance.
- If a conveyor is twisted along the axis of the edge of the chain, the product will maintain the same elevation. If the twist is along the conveyor's chain center line, a natural incline or decline of the products will occur.

NOTES:

The information provided are guidelines only. This does not represent all design variations possible. For detailed or specific design requirements ,please contact a representative or email info@spantechllc.com.

ENDLESS LOOP

The Endless Loop conveyor is a great option when the need to completely eliminate transfers is required.

Functionality

Endless Loops are very functional in assembly line applications and in applications with small products, completely eliminating the need for transfers.



RULES OF THUMB FOR ENDLESS LOOPS

- Endless Loop conveyors can use 1 or 2 Outrunner Drives using a single VFD.
- If more than 2 Outrunner Drives are necessary, special controls are necessary.
- Any length of loop is possible.
- Outrunner Drives must be located on the curves.
- Endless Loops are especially good for inspection / assembly systems.
- Endless loops are relatively less expensive than standard conveyors because they use half the chain.

NOTES:

The information provided are guidelines only. This does not represent all design variations possible. For detailed or specific design requirements, please contact a representative or email info@spantechllc.com.

CONVEYORS

[ACCUMULATION]

The information provided are guidelines only. This does not represent all design variations possible. For detailed or specific design requirements ,please contact a representative or email info@spantechllc.com.

ACCUMULATION

Accumulation: *Delaying the arrival of products by stopping them on the conveyor chain as the chain continues to move.*

Requirements:

1. Only products with smooth bottom surfaces should be accumulated to prevent them from being damaged by the chain.
2. Products need parallel front and back surfaces in order to have consistent contact with each other during accumulation.
3. Once square and rectangle products are released into curves, products in front are pushed forward because of the effect of the curving path on square objects.

CORRECT

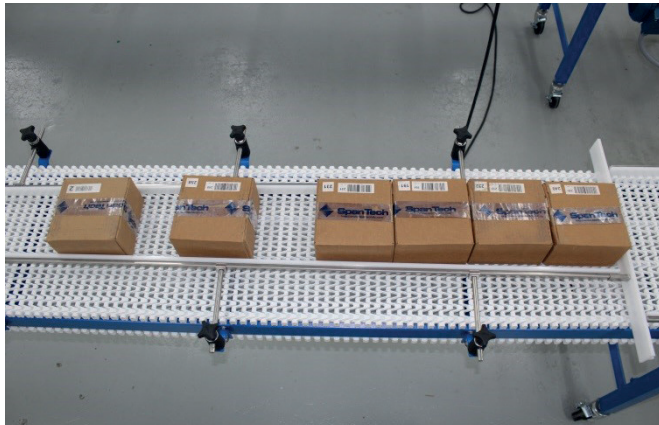

INCORRECT

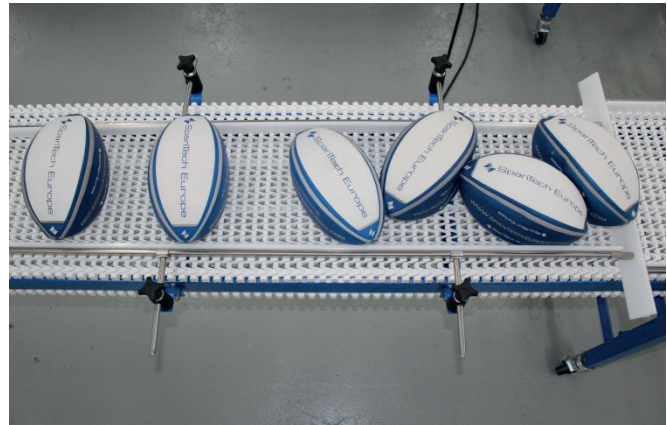

NOTES:

The information provided are guidelines only. This does not represent all design variations possible. For detailed or specific design requirements, please contact a representative or email info@spantechllc.com.

ACCUMULATION

Accumulation on Tube Top Chain:



- Back pressure decreases drastically when accumulating on Tube Top Chain.
- Increasing the angle of the Tube Top accumulation conveyor can drop the back pressure further.
- Because the tubes roll underneath the product during accumulation, the product surface is not damaged during accumulation.

Tube Top Chain was created so more products could be accumulated than what was possible on plain chains. The tubes rotate freely under products stopped on the chain, allowing a longer slug of products to accumulate without crushing the first product.

NOTES:

The information provided are guidelines only. This does not represent all design variations possible. For detailed or specific design requirements ,please contact a representative or email info@spantechllc.com.

ACCUMULATION

Accumulation on Curved Conveyors:



Accumulated Round Products:

Pull a gap as the product exits the 180° bend due to the compression and expansion of the conveyor chain underneath the product. Accumulated round products maintain orientation because they keep a single point of contact through the curve.

Accumulated Square Products:

Pull a gap as the product exits the 180° bend due to the compression and expansion of the conveyor chain underneath the product. Accumulated square products also skew as they exit the curve due to the point of contact shifting from the product side to the corner as it moves through the curve. Square products can also lock up and get wedged between the guiderail.

NOTES:

The information provided are guidelines only. This does not represent all design variations possible. For detailed or specific design requirements, please contact a representative or email info@spantechllc.com.

CONVEYORS

[DRIVES & GEAR MOTORS]

The information provided are guidelines only. This does not represent all design variations possible. For detailed or specific design requirements ,please contact a representative or email info@spantechllc.com.

DRIVES

Flexibility matched with power and durability is the essence of Span Tech drives.

The conveyor chain flexes around the end of the conveyor, over the drive sprockets, and continues underneath without ever leaving the frame. There is no loose catenary to contend with. The chain will be captured at all times.

Drive sprockets are two piece units making maintenance and repair quick and simple. The drive shaft does not have to be removed for sprocket replacement. Sprockets are also protected by a shear pin making an expensive friction clutch unnecessary.

The drive sprockets are mounted on a 1 1/4" diameter stainless steel drive shaft. One end of this drive shaft can extend out-whichever side of the conveyor is preferred.

Drives and idlers are identical in design. The conveyor drive can be positioned at either end of the conveyor, or either side resulting in either a push or pull drive or somewhere in the center using an intermediate drive.

Various drive arrangements are possible with Span Tech family of conveyors such as the hollow shaft mount, remote mount (chain and sprockets) and the coupled mount. A selection of motor and gearbox combinations are available to power Span Tech conveyors in the most demanding applications.

The MultiSpan, MonoSpan and 25mm SuperTight sprocket assembly has 21 teeth and a pitch radius of 3.29" (83.5mm). Chain travel per sprocket revolution is equal to 1.72 ft. (0.52 meters).

The MaxiSpan and 50mm SuperTight sprocket assembly has 11 teeth and a pitch radius of 3.49" (88.7mm). Chain travel per sprocket revolution is equal to 1.83 ft. (0.55 meters).

MultiSpan, MonoSpan and 25mm SuperTight chain speed can be calculated using the following formulas.

$$\text{Chain speed}^{(ft/min)} = \text{shaft rpm} \times 1.72 \text{ ft.}$$

$$\text{Chain speed}^{(meters/min)} = \text{shaft rpm} \times 0.52 \text{ meters.}$$

MaxiSpan and 50mm SuperTight chain speed can be calculated using the following formulas.

$$\text{Chain speed}^{(ft/min)} = \text{shaft rpm} \times 1.83 \text{ ft.}$$

$$\text{Chain speed}^{(meters/min)} = \text{shaft rpm} \times 0.55 \text{ meters.}$$

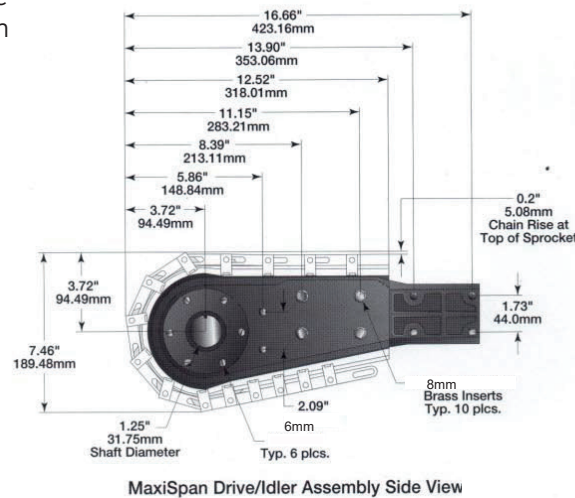

The illustrations shown represent typical space requirements and location dimensions of standard drive and idler assemblies for Span Tech conveyors.

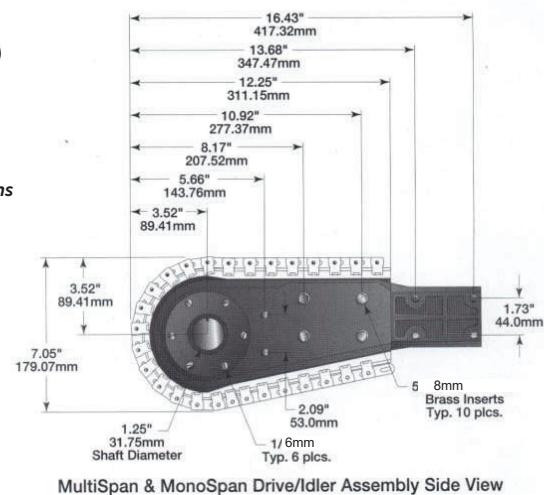

The information provided are guidelines only. This does not represent all design variations possible. For detailed or specific design requirements, please contact a representative or email info@spantechllc.com.

INTERMEDIATE DRIVE

The placement of the garmotor at the intermediate drive eliminates the need to allow motor space at the conveyor end.

Optimal Use

Used to power a conveyor between the infeed and outfeed ends.

Low Profile Idler

Allows either end (or both) to use a low profile idler.

Perfect for Small Product

Advantageous for end-to-end transfers where smaller products would be difficult to transfer.

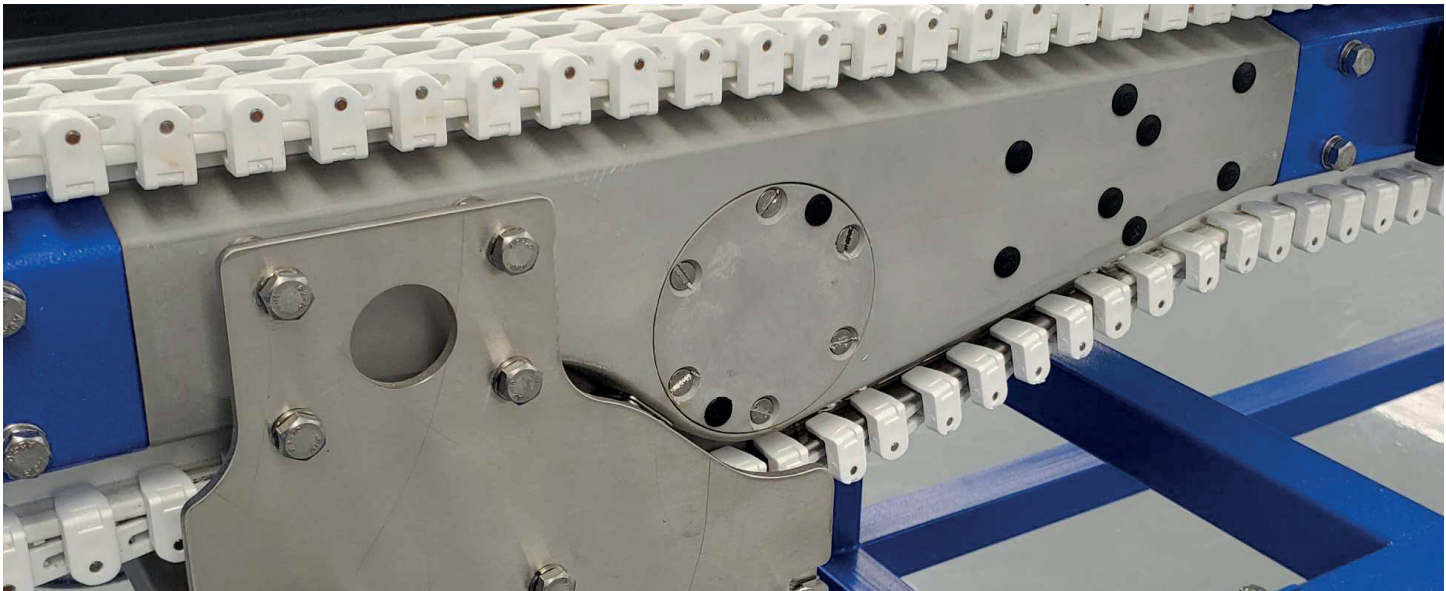

RULES OF THUMB FOR INTERMEDIATE DRIVES

- One-direction only and must be mounted accordingly
- Has limited chain pull compared to a standard drive unit (60%).
- Requires a plain chain link wherever sprockets are located.
- Can be made compatible with Closed-Top chain (rollers are fine, non-rollers requires special design).
- Will NOT work for taller cleated chain (unless there is a plain link in sprocket rows, breaking up a continuous cleat).
- Will NOT work with Maxispan or 50mm SuperTight chain.
- If used on an incline conveyor, an Intermediate Drive must be placed so that it is always pulling on tensioned chain - make sure slack chain can never build up at the pinch roller (happens whenever the conveyor is stopped quickly).

- For inclining/declining conveyors, it is best practice to place the Intermediate Drive as close to the highest point on the conveyor as possible.
- Requires 500ms (0.5 seconds) minimum of deceleration time when stopping.
- It is best practice to place the Intermediate Drive close to the discharge end of the conveyor if possible.
- Only compatible with MultiSpan and SuperTight chain families .

NOTES:

The information provided are guidelines only. This does not represent all design variations possible. For detailed or specific design requirements ,please contact a representative or email info@spantechllc.com.

HOLLOW BORE GEARMOTOR

Easy to maintain, service, or replace, our popular Hollow Bore Gearmotors are reliable and keep operations running smoothly and on time.

EASY MAINTENANCE

The Hollow Shaft Mount design facilitates easy maintenance and simplifies removal/replacement if necessary.



RULES OF THUMB FOR HOLLOW SHAFT MOUNTS

- Span Tech uses Hollow Bore Gearmotors as standard. Span Tech driveshaft diameter is 1.25".
- Other brands of gearboxes are available on request.
- Coupled gearmotors and remote chain drive gearboxes are also available on request.
- Gearmotors can be ordered in various degrees of washdown from standard non-washdown to all stainless.
- A standard VFD can be ordered with the conveyor wired to the gearmotor ready to run.
- A conveyor can be dual driven, meaning one gearmotor on the infeed of the conveyor "pushing" and the other on the discharge end "pulling" the conveyor. This requires both motors wired to a single VFD sized to handle the horsepower of both motors.
- Further control packages can be ordered on request.

NOTES:

The information provided are guidelines only. This does not represent all design variations possible. For detailed or specific design requirements, please contact a representative or email info@spantechllc.com.

OUTRUNNER DRIVE

OutRunner Drives are typically used in continuous loop systems with top running chain only.

Accumulation

Outrunner Drives are the perfect solution for Endless Loop conveyors.



RULES OF THUMB FOR OUTRUNNER DRIVES

- Outrunner Drives power the conveyor chain from the side of the chain instead of chain wrapped around sprockets inside the conveyor.
- Outrunner Drives must be placed on an outside curve only. They are not suitable for straights or inside curves.
- Up to 2 Outrunner Drives can be used on a single conveyor using a single VFD. More than 2 Outrunner Drives require special controls.
- The Outrunner Drive can be configured to drive only the top chain (this is useful in making Endless Loop Conveyors) or the top and bottom chain in a standard conveyor with idlers on each end.
- Includes follower sprocket mechanism that will stop the drive if it is "tripped". This is a safety mechanism to prevent things from getting pulled into the drive. Additionally, it will also stop the drive if a side link is missing.

NOTES:

The information provided are guidelines only. This does not represent all design variations possible. For detailed or specific design requirements ,please contact a representative or email info@spantechllc.com.

NORD GEARMOTORS

General Information:

Nord is the standard gearmotor of choice from Span Tech. We typically use the SK2040.1, SK02050 & SK12063 from Nord but every job is different and the gearmotor will be job specific. They are wired for any country's electric standards.

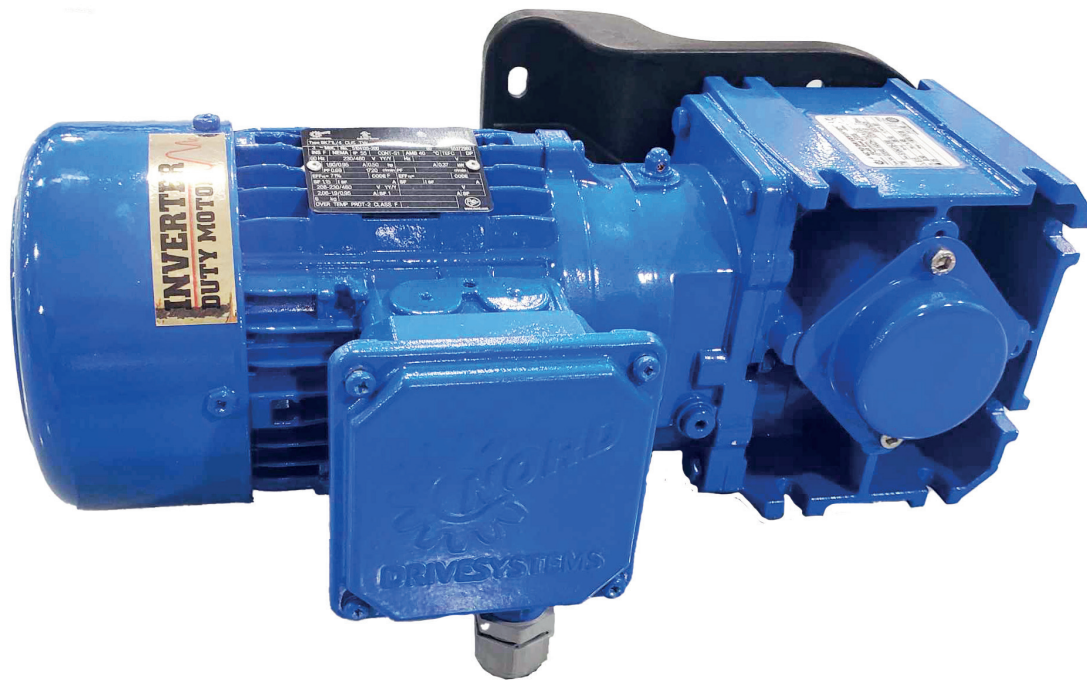

BENEFITS OF NORD GEARMOTORS:

Powerful

The gear units provide high axial and radial load capacities and achieve high drive torques up to 880,000 lb-in.

Rugged

The UNICASE housing combines high precision, rigidity and strength.

Flexible

When required, NORD can furnish customizable gear motor solutions with options like brakes, encoders and many more!

Modular

Thanks to NORD'S modular design, you can combine the gearboxes with all motors from the NORD product offering.

The information provided are guidelines only. This does not represent all design variations possible. For detailed or specific design requirements, please contact a representative or email info@spantechllc.com.

SEW GEARMOTORS

General Information:

Span Tech uses WA, SA, and KA Gearmotors from SEW. They are wired for any country's electric standards.

SA Gearmotor:

- Slightly more expensive than the W series.
- Boasts an efficiency rating of around 85%.
- SA47 most common Gearmotor used.
- Offers hundreds of reduction ratios.



KA Gearmotor:

- Most efficient and expensive gear box we use (94%-98%).
- Most robust Gearmotor SEW makes as it uses steel gearing.
- Designed to run constantly with high cycling rates with continuous load.



WA Gearmotor:

- Worm Gearmotor allows motor to handle shock loading, and constant starting and stopping.
- Least expensive and least efficient (around 60%).
- Because this is a smaller horse power motor, there are fewer gear ratios than S or K.

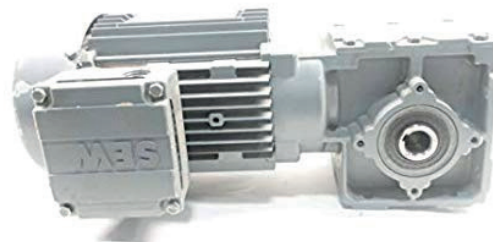

The information provided are guidelines only. This does not represent all design variations possible. For detailed or specific design requirements ,please contact a representative or email info@spantechllc.com.

MORE GEARMOTOR OPTIONS

BRAKE MOTORS

- Often used as a “safety lock” to prevent the shaft from moving after it has already stopped.
- Not meant to stop the rotation of a shaft quickly.
- Acts like an parking brake not a brake pedal.



Z FAN

- Optional cast iron fan on gearmotors when the conveyor speed is over 120/fpm.
- Acts as a mechanical soft start and soft stop for the gearmotor.
- Reduces wear on the internal gears.

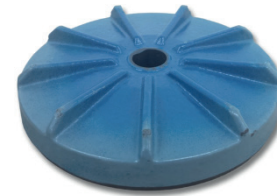

GEARMOTOR CONTROLS



Motor Starter:

- On/Off switch



Variable Frequency Drive

- Can change speeds.
- Ramp ups and shutdowns.
- Change direction of the motor.
- Has overload protection.

The information provided are guidelines only. This does not represent all design variations possible. For detailed or specific design requirements, please contact a representative or email info@spantechllc.com.



CONVEYORS

[ADD ONS]

The information provided are guidelines only. This does not represent all design variations possible. For detailed or specific design requirements, please contact a representative or email info@spantechllc.com.

EZGUIDE GUIDERAIL [FIXED & ADJUSTABLE]

ELIMINATES SAFETY CONCERNS

No protruding brackets or rods. All the mechanics of EZGUIDE™ are done without the need to protrude past the conveyor keeping everything safe for those walking close or near.

ADJUSTABLE THROUGH CURVES

The radius of EZGUIDE changes as the guide width is increased/decreased in the curve.

FASTER CHANGEOVERS

Additional tools are not required when adjusting the guide rail, which reduces product changeover time.

PRODUCT JUSTIFICATION

Combine fixed and adjustable to give you ultimate control of which side of the conveyor you would like your product to be justified to.

QUICK AND COST EFFECTIVE INSTALLATION

EZGUIDE™ is flexible enough to install yourself allowing you to bend the railing to the radius you desire on site.

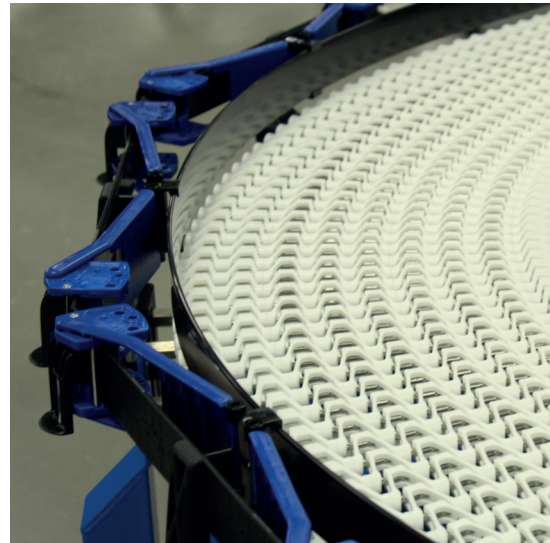

RULES OF THUMB FOR EZGUIDE GUIDE RAIL

EZGUIDE GUIDE RAIL BRACKET TYPES:

EZGUIDE General Rules of Thumb

- Sold in 16 ft lengths
- Max Overhang from a bracket - 347mm (13.6")
- Max Spacing between brackets - 610mm (24")
- Minimum 2 points of contact
- Guide rail must be overlapped in the direction of flow at end of each section.

EZGUIDE Adjustable guide rail

- Minimum spacing between guide rail brackets
 - 50mm - 292mm (11.5")
 - 100mm - 400mm (15.75")

AVAILABLE IN 3 MATERIAL OPTIONS

- Curved Hard Coat Anodized (Black)
- Flat Face Hard Coat Anodized (Black)
- Flat Faced HDPE Coated (White)

NOTES:

The information provided are guidelines only. This does not represent all design variations possible. For detailed or specific design requirements ,please contact a representative or email info@spantechllc.com.

VALUGUIDE GUIDE RAIL

FEATURES:

- Used to guide product to a certain position on the conveyor. To align product with another conveyor, transfer or for automation.
- Used to stabilize product and keep contained on the conveyor for safety.
- Required when accumulating product to prevent products from “walking” off the conveyor and placed above the top of products to keep from popping up when in accumulation.



GUIDE RAIL BRACKET TYPES:

ValuGuide Adjustable (stainless or painted)

- Variable product sizes.
- Ability to adjust to an angle.
- Easy to adjust width but more difficult to adjust height. (spacers required)

Standard Adjustable (stainless or painted)

- Easy to adjust height and width.
- Limited width adjustments.
- Not as washdown friendly.

Fixed Channel Brackets (stainless, painted or molded)

- Fixed product sizes.
- Fixed horizontal width.
- More cost effective than flat offset brackets.

Fixed Flat Offset Brackets (stainless or painted)

- Fixed product sizes.
- Horizontal offset can be tooled to wider widths.
- Higher cost bracket than channel brackets.

GUIDE RAIL TYPES:

Span Tech keeps an inventory in stock of three types of guide rails. Each rail is UHMW with a stainless-steel backing.

- 1/2" round rail
- 1 1/4" T-rail (flat profile)
- 2 1/4" T-rail (flat profile)

NOTES:

The information provided are guidelines only. This does not represent all design variations possible. For detailed or specific design requirements, please contact a representative or email info@spantechllc.com.

SIDE WALLS

FEATURES:

- Used to guard against the moving sides of the conveyor.
- Functions as a guide for products on the conveyor.

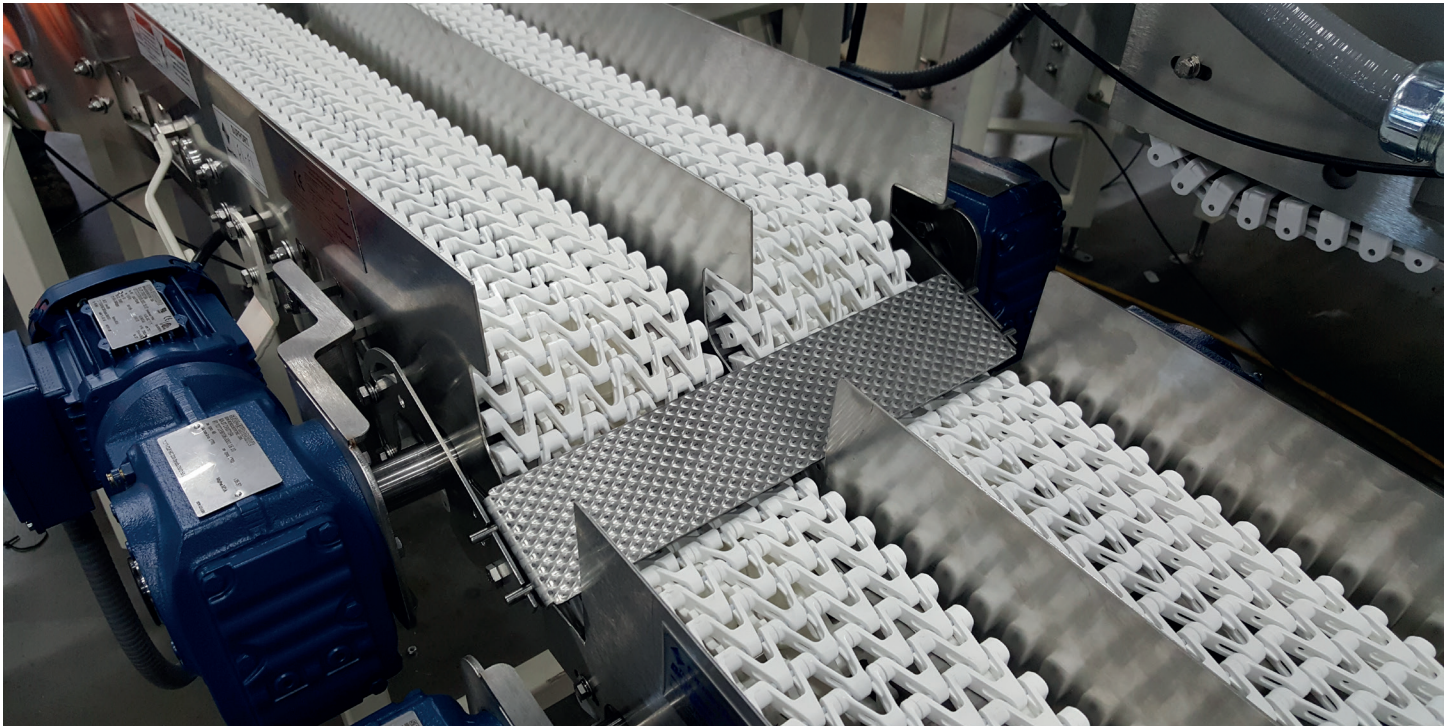

SIDE WALL TYPES:

Stainless Steel

- Higher cost.
- Most durable.

UHMW

- Most cost effective.
- Lower coefficient of friction.
- Will not scratch or crack.
- May expand or contract in varying temperatures.

Lexan

- Cost effective.
- Lighter weight.
- Can scratch and wear over time.
- Can crack if over-tightened.

NOTES:

The information provided are guidelines only. This does not represent all design variations possible. For detailed or specific design requirements ,please contact a representative or email info@spantechllc.com.

TRAFFIC COP

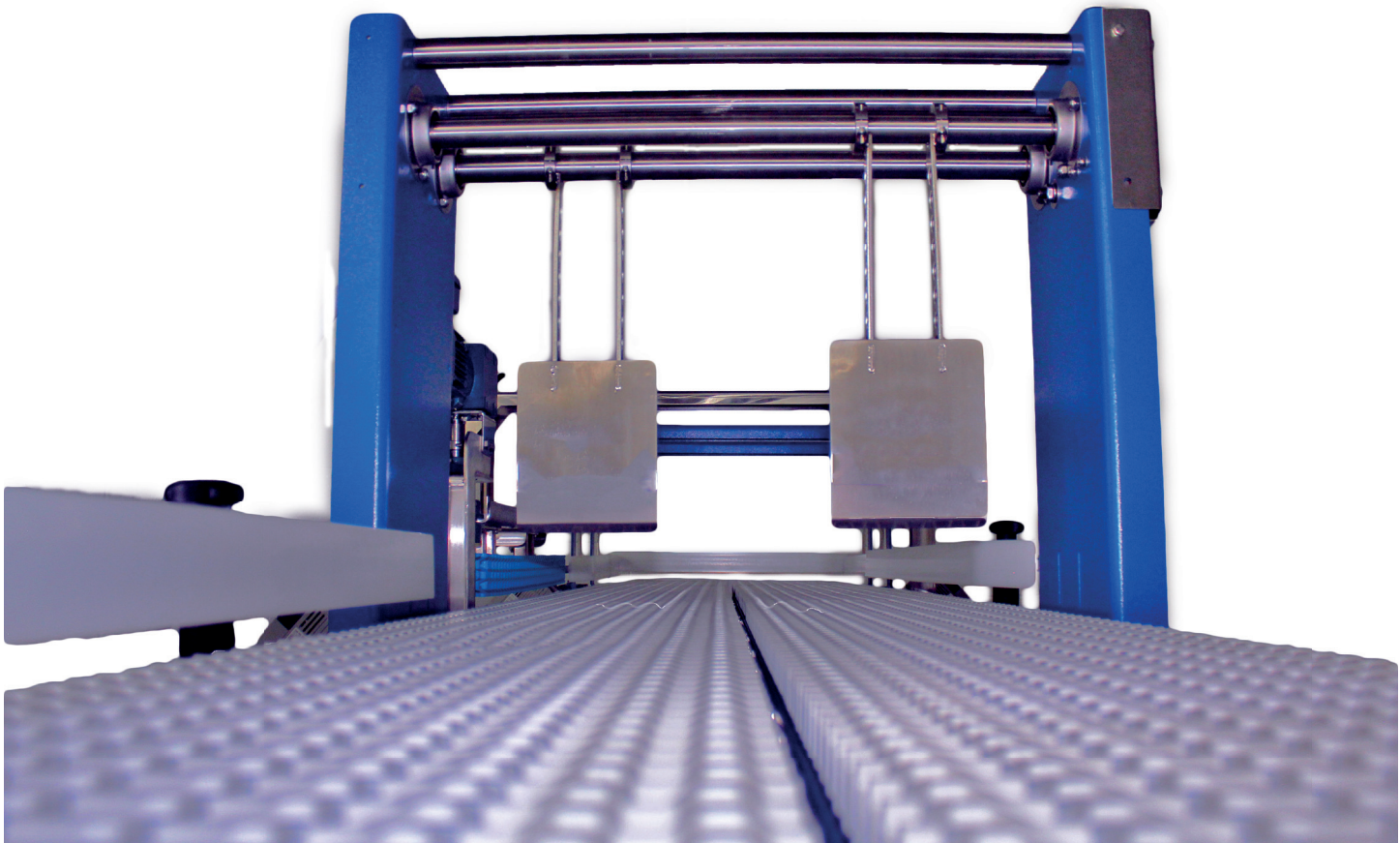

FEATURES:

- Designed as a pair of mechanically linked arms to orchestrate product flow for a smooth merge from two conveyor lanes to one lane of product, having uniform or non-uniform sizes and weights.
- Arms alternately hold back and then release the product, and are mechanically locked so that they cannot both release product at the same time.
- Using the mechanical design, operates without the use of sensing devices, I/O components, or powered automation.
- Works only on rigid products with the ability to accumulate.
- Low cost method for combining lanes.

NOTES:

The information provided are guidelines only. This does not represent all design variations possible. For detailed or specific design requirements, please contact a representative or email info@spantechllc.com.

BUMP ROTATE

FEATURES:

- Intentional obstruction in the path of the product on a conveyor which causes the product to rotate and change orientation 90°.
- Two Bump Rotates can be used to rotate the product 180 °.
- Mechanical design operates without the use of sensing devices, I/O components, or powered automation.
- Generally requires guide rail after the Bump Rotate to straighten the product.
- Temporarily slows the product down on the conveyor which is why a minimum [pitch rule \(see below\)](#) must be followed.

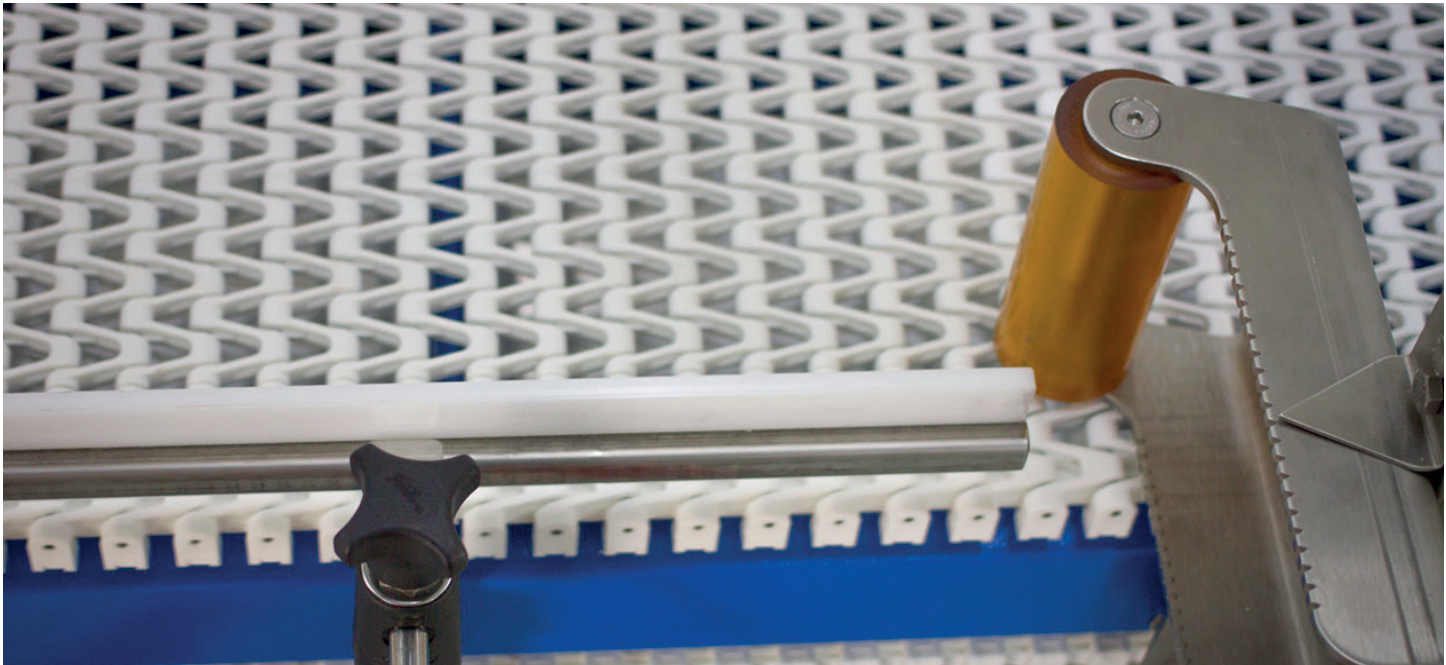

PITCH RULES:

Roller Chain $V = (W \times 3.2) \times R$

- V = Conveyor Speed (fpm)
- W = Incoming Product Dimension (ft.)
- R = Max production rate (products per meter)

**an acceleration zone or metering stop may be necessary to achieve the correct product spacing.*

High Friction Chain $V = (W \times 2.0) \times R$

- V = Conveyor Speed (fpm)
- W = Incoming Product Dimension (ft.)
- R = Max production rate (products per meter)

NOTES:

The information provided are guidelines only. This does not represent all design variations possible. For detailed or specific design requirements ,please contact a representative or email info@spantechllc.com.

METAL DETECTOR SECTIONS

FEATURES:

- Conveyor section designed to use with customer-supplied metal detectors.
- Conveyors designed with MaxiSpan or MonoSpan chain types.

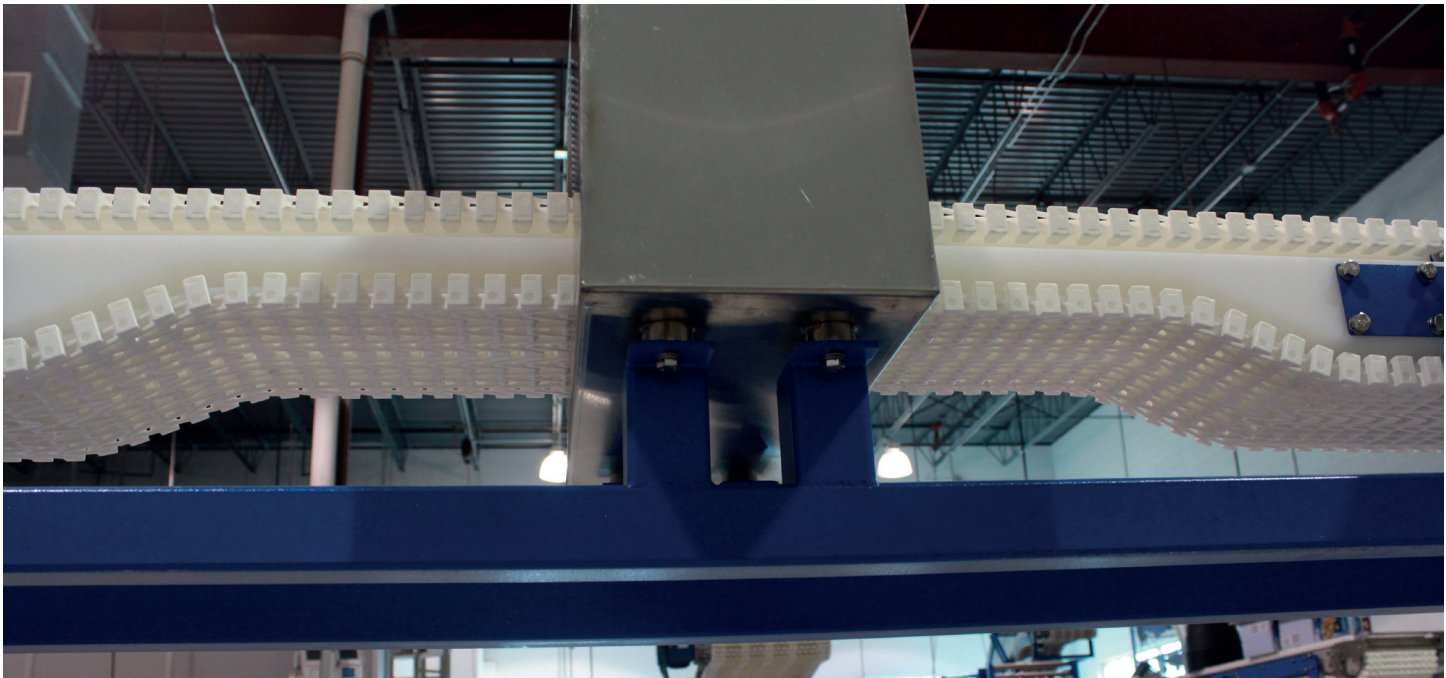

TYPES OF METAL DETECTOR SECTIONS:

Low Profile Metal Detector Sections

- More cost effective.
- Both top and bottom chain pass through the metal detector.
- Requires larger clearance area in metal detector since both top and bottom chain pass through metal detection area.

Split Bed Metal Detector Sections

- Higher Cost.
- Only top layer of chain passes through metal detector.
- Smaller clearance area since only the top chain passes through the metal detector area.

NOTES:

The information provided are guidelines only. This does not represent all design variations possible. For detailed or specific design requirements, please contact a representative or email info@spantechllc.com.

VARIABLE FREQUENCY DRIVE

FEATURES:

- Controlled start/stop (for smooth acceleration/ deceleration of the motor).
- Automatic or manual changes to the speed of the motor while its running.
- Ability to reverse the direction of the motor.
- Overload protection.
- Feedback for how much voltage/amps the motor is using while its running.
- Can be controlled via external devices (PLC).
- VFD's are sized according to the amount of power they will need to supply to the electromechanical device they are powering.



NOTES:

The information provided are guidelines only. This does not represent all design variations possible. For detailed or specific design requirements ,please contact a representative or email info@spantechllc.com.

CLEAN OUT HOLES

Clean Out Holes are used when sanitation is a very high priority. They allow for better access to the inside of the conveyor bed for effective and less time consuming washdown.



CLEAN OUT HOLE OPTIONS:

- **ROUND HOLES**– \varnothing 2 1/8" clean-out holes, located on 3 7/16" centers, included in the straight frame sections only and dependent on bed section length.
- **SLOTTED HOLES**– 4 3/8" long clean-out holes, located on 2.719" centers, included in the straight frame sections only and dependent on bed section length.

DRIP TRAYS

Drip Trays are designed to catch liquids and debris that could fall off the conveyor. Drip trays are custom designed for each individual conveyor.



NOTES:

The information provided are guidelines only. This does not represent all design variations possible. For detailed or specific design requirements, please contact a representative or email info@spantechllc.com.

LOW PROFILE IDLER

FEATURES:

- Low Profile Idlers' slim design can eliminate the need for transfer devices at the conveyor infeed or discharge.
- Moves product as small as 4.5" without stalling or using a transfer bridge.
- Existing conveyors can be directly retrofitted with the Low Profile Idler. If your product changes, your conveyors can change with it.



RULES OF THUMB FOR LOW PROFILE IDLERS

- The Low Profile Idler is the same length as the standard idler unit and they are interchangeable.
- The Low Profile Idler has a 3.4" nose diameter.
- Low Profile Gravity Roller Transfers are used in conjunction with Low Profile Idlers (2, 3, or 4 rollers).
- 50mm MultiSpan, MaxiSpan and MonoSpan chains are not compatible with Low Profile Idlers.
- Low Profile Idlers should not be used with Closed Top chain over 25.02" wide.

NOTES:

The information provided are guidelines only. This does not represent all design variations possible. For detailed or specific design requirements ,please contact a representative or email info@spantechllc.com.

LANE DIVIDERS

- Suspended from above the conveyor to create multiple rows for products on the same conveyor.
- Made of sidewall or guiderail.
- Made to be fixed or adjustable for straight sections only.



LEXAN SAFETY GUARDING

Lexan guarding is an option for certain applications where safety could be a concern. For example the High Speed Switch is an where contact with the conveyor could result in injury*.

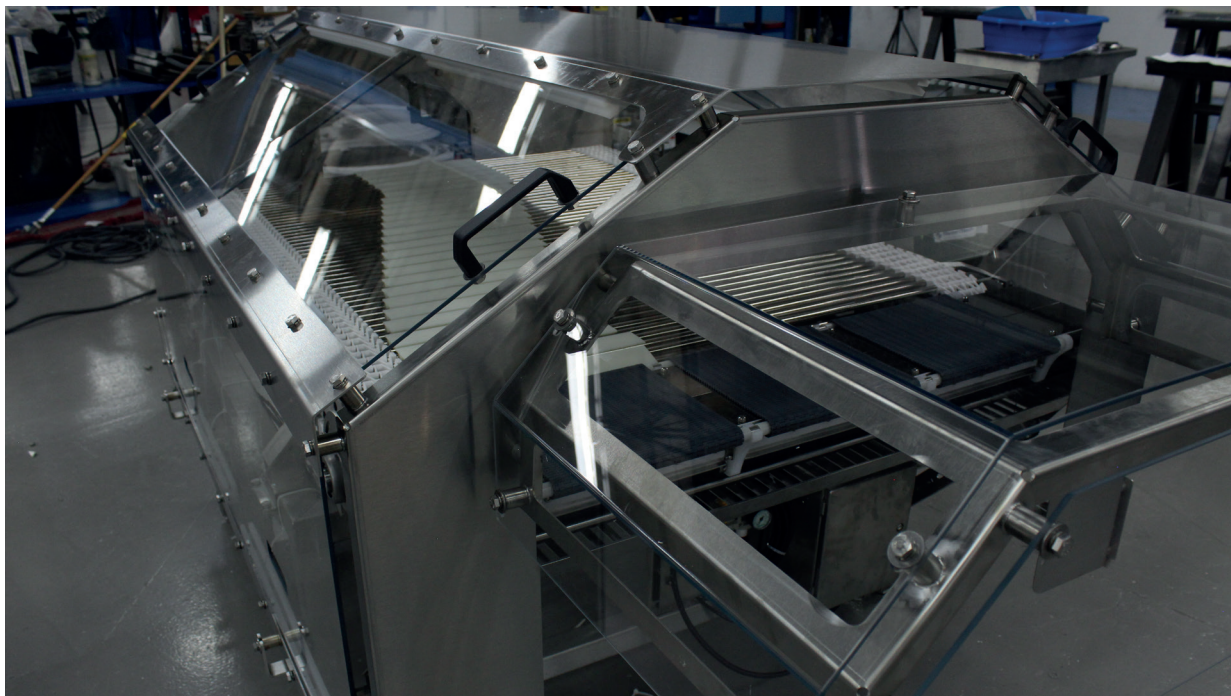

**The safety of any conveyor system is ultimately the responsibility of the end user. The lexan guarding provided, while very sturdy and capable of offering adequate protection from moving parts, does not follow a specific guarding or OSHA guideline.*

The information provided are guidelines only. This does not represent all design variations possible. For detailed or specific design requirements, please contact a representative or email info@spantechllc.com.

CONVEYORS

[TRANSFERS]

The information provided are guidelines only. This does not represent all design variations possible. For detailed or specific design requirements ,please contact a representative or email info@spantechllc.com.

GRAVITY TRANSFER

Non powered transfer solution that provides an ideal way to move your products.

Easy Removal

Gravity Transfers' roller bridge can be easily lifted out and replaced when needed.

Options Available

Standard: 3 or 6 roller options.

Low Profile Idler: 2, 3 or 4 roller options.

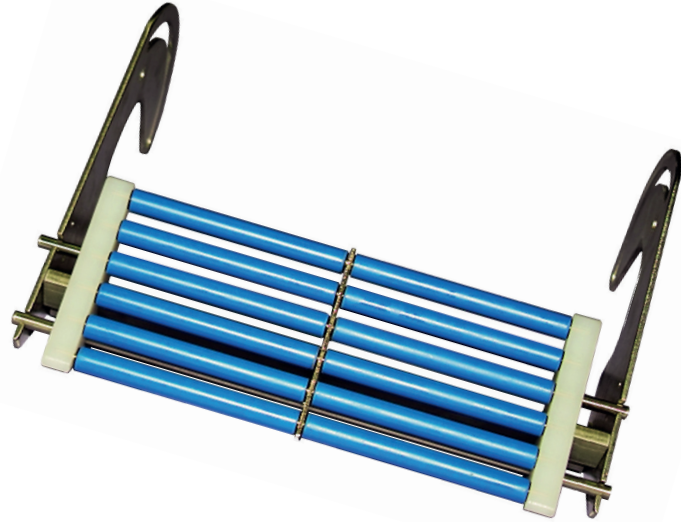

END TO END / GRAVITY TRANSFER

- Product sized down to 9" can be transferred at any speed.

END TO END / LOW PROFILE GRAVITY TRANSFER

- Product sized down to 6.5" can be transferred at any speed.

LOW PROFILE END TO END / LOW PROFILE GRAVITY TRANSFER.

-Product sized down to 5.5" can be transferred at any speed.

RULES OF THUMB FOR GRAVITY TRANSFERS

- Small products are possible at speeds of 120 fpm (36.5 mpm) and higher.
- When using a Low Profile Idler, conveyor speeds are limited to 150 fpm.
- This transfer is typically not used with bag products because their flaps or seams could get caught between rollers.
- All Gravity Transfers have the ability to be pitched up or down to a maximum 15° angle.
- Fingers are available with raised chain.

NOTES:

The information provided are guidelines only. This does not represent all design variations possible. For detailed or specific design requirements, please contact a representative or email info@spantechllc.com.

MICROSPAN TRANSFER

The MicroSpan Transfer is a compact, durable, powered transfer solution that is built to last.

Drive Options

Can be slave driven or independently driven.

Easy Configuration

Inner module can be removed without tools for fast change out.

High Speeds

Available for high speed applications of over 150 fpm.

Versatile

Can be used in incline or decline applications.

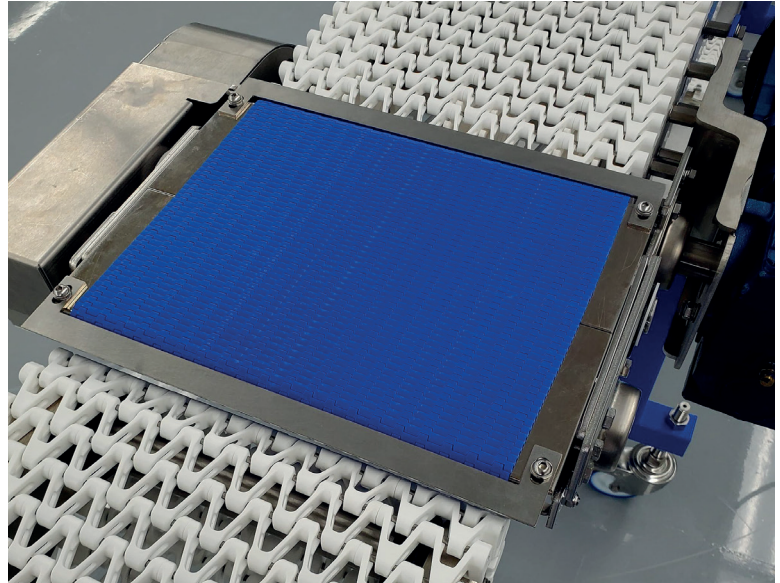

RULES OF THUMB FOR MICROSPAN TRANSFERS

- CHAIN OPTIONS:
 - 4mm plain or raised & 6mm plain or raised.
- PLAIN CHAIN
 - Products as small as 3" in length may be transferred at any speed.
- PLAIN CHAIN WITH STAINLESS LIP
 - Products as small as 2.8" in length may be transferred at any speed.
- RAISED CHAIN
 - Products larger than 2.8" in length can be transferred at any speed.
- Smaller products may be possible at speeds of 60 fpm or higher depending on individual characteristics.

NOTES:

The information provided are guidelines only. This does not represent all design variations possible. For detailed or specific design requirements, please contact a representative or email info@spantechllc.com.

WIRE MESH TRANSFER

Perfect for avoiding sticky situations.

Drive Options

Can be slave driven or independently driven.

Innovative Design

The Wire Mesh design makes it perfect for use near freezers, ovens, or in sticky areas.

Configurable

Inner module can be removed without tools for fast change outs.

Versatile

Can be used in incline or decline applications.

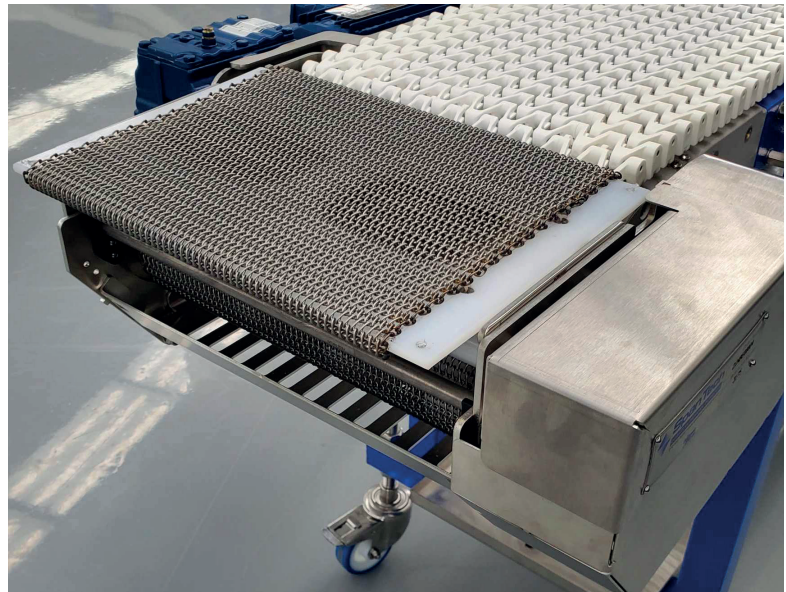

RULES OF THUMB FOR WIRE MESH TRANSFERS

- Products as small as 3" in length can be transferred at any speed.
- Smaller products may be possible at 120 fpm or higher depending on individual product characteristics.
- Wire Mesh Transfers initial cost is higher than that of other transfers and the need to order and create custom components gives it a longer lead time. Span Tech recommends purchasing a spare Wire Mesh belt with the order. Servicing tasks can also be more complex, since the chain must be welded and ground for assembly or servicing.

NOTES:

The information provided are guidelines only. This does not represent all design variations possible. For detailed or specific design requirements, please contact a representative or email info@spantechllc.com.

HORIZONTAL BALLISTIC TRANSFER

Horizontal ballistic transfers are the most basic transfers that Span Tech offers. They are the most cost efficient of all SpanTech transfers because no additional hardware is needed. Products are transferred from one conveyor to the next. These transfers are flat with no elevation changes.

PRODUCT REQUIREMENTS FOR ALL

- Small products may be possible depending on product characteristics and conveyor speed.
- Product should be stable.
- These methods are not suitable for products small enough to dip into the gap between conveyors.

HORIZONTAL STANDARD TO STANDARD BALLISTIC TRANSFER

The product is transferred from a standard drive to a standard idler.

- Small products may be possible depending on product characteristics and conveyor speed.
- Product should be stable.
- These methods are not suitable for products small enough to dip into the gap between conveyors.

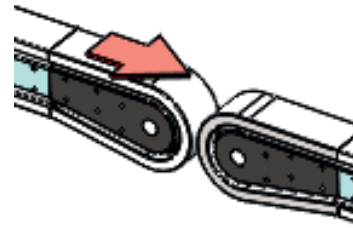

HORIZONTAL STANDARD TO LOW PROFILE BALLISTIC TRANSFER

The smaller radius of the low profile design provides a shorter transfer gap. This transfer has a slightly higher cost due to the use of the low profile idler.

- Products as small as seven inches (177.8 mm) may be possible depending on product characteristics and conveyor speed.
- When using a low-profile idler, conveyor speed in general is limited to 175 feet per minute (53.54 mpm).

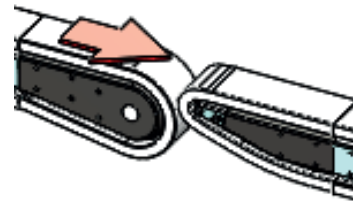

HORIZONTAL LOW PROFILE TO LOW PROFILE BALLISTIC TRANSFER

With both conveyors having the low profile design, this technique provides the shortest ballistic transfer gap and can handle the smallest product of any ballistic transfer configuration. This transfer has a slightly higher cost due to the use of a low profile idler.

- Products as small as six inches (152.4 mm) may be transferred.
- When using a low profile idler, conveyor speed in general is limited to 175 feet per minute (53.54 mpm).



The information provided are guidelines only. This does not represent all design variations possible. For detailed or specific design requirements ,please contact a representative or email info@spantechllc.com.

OFFSET BALLISTIC TRANSFER

Another method of product transfer is known as an offset transfer (also called a waterfall transfer). An offset transfer occurs when a product is dropped from the end of one conveyor onto a second conveyor, positioned at a lower elevation. This method is usually used for bulk product flow or product in bags. An offset transfer adds no cost but can cause the product to tumble during transfer. Products may also lose orientation during transfer so guide rails or moving side guides may be required.

PRODUCT REQUIREMENTS FOR ALL

- Small Products may be possible depending on product characteristics and conveyor speed.

OFFSET STANDARD TO STANDARD BALLISTIC TRANSFER

The product is transferred from a standard drive to a standard idler.

- Products with a minimum length of 8.5 inches (215.9 mm).

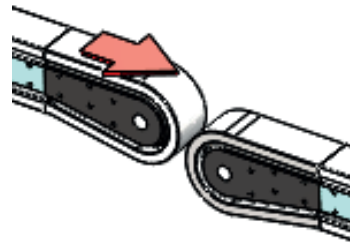

OFFSET STANDARD TO LOW PROFILE BALLISTIC TRANSFER

The smaller radius of the low profile design provides a shorter transfer gap. This transfer has a slightly higher cost due to the use of the low profile idler.

- Products as small as 7.5" (177.8 mm) may be transferred.
- When using a low profile idler, conveyor speed in general is limited to 175 feet per minute (53.54 mpm).

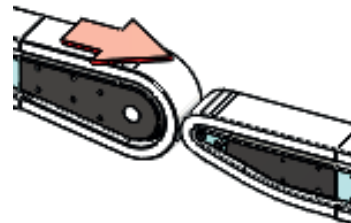

OFFSET LOW PROFILE TO LOW PROFILE BALLISTIC TRANSFER

The low profile to low profile offset ballistic transfer offers the shortest transfer distance possible without the use of a transfer device.

- Products as small as 5.75" (146.05 mm) may be transferred.
- When using a low profile idler, conveyor speed in general is limited to 175 feet per minute (53.54 mpm).
- Smallest transfer distance without using a device.

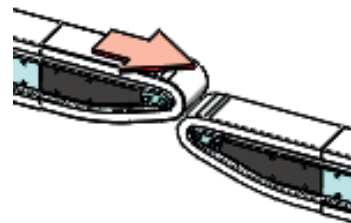

The information provided are guidelines only. This does not represent all design variations possible. For detailed or specific design requirements, please contact a representative or email info@spantechllc.com.

DEAD PLATE TRANSFER

A dead plate transfer uses a flat piece of stainless steel or UHMW to bridge the gap between conveyors. As with all Span Tech transfers, the dead plate transfer incorporates a lift-out design – an important safety feature in the event that anything becomes caught between the transfer and conveyor.

PRODUCT REQUIREMENTS FOR BOTH

- Smaller products are possible at speeds of 120 feet per minute (36.576 mpm) and higher.
- Raw or sticky material is likely to stall on a dead plate transfer.
- This method can only be used in applications where the conveyor runs fast enough to reliably propel the product across the unpowered transfer bridge.
- Transfer is not suitable for most bagged products as their flaps or seams could get caught in the transfer.
- Designed with a safety lift-out feature.

HORIZONTAL STANDARD TO STANDARD DEAD PLATE TRANSFER

- Products as small as 8.5" (215.9 mm) can be transferred at any speed.
- Best suited for higher-speed conveyors carrying larger, rigid products.

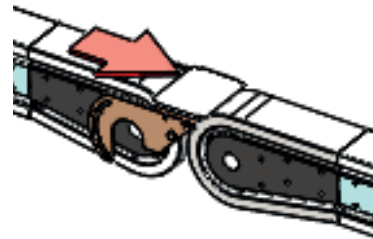

OFFSET STANDARD TO STANDARD DEAD PLATE TRANSFER

The offset dead plate transfer is similar to an offset transfer. Due to the downhill angle of the plate, the offset dead plate transfer can work with conveyor speeds slower than those compatible with the standard dead plate. Like the offset ballistic transfer, the offset dead plate may cause products to tumble, and therefore may require the use of guide rails for some applications.

- Products as small as 8.5" (215.9 mm) can be transferred at any speed.
- Best suited for higher-speed conveyors carrying larger, rigid products.

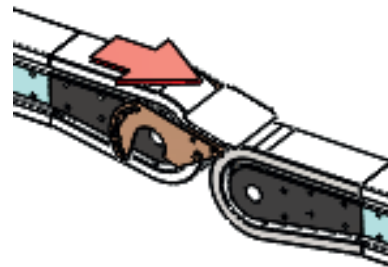

TRANSFER FINGERS

Between the conveyor and transfer there is a small gap which could cause problems with transferring smaller products. One way to reduce this gap is to use fingers (in combination with raised chain). Fingers are made from molded plastic and are designed to sit in between the raised rows of the conveyor chain. These fingers act as a very small dead plate transfer with the added advantage that there is no leading edge for the product to catch on.

Fingers can be used with plain chain, but this is considered a special application and is typically not necessary.

Fingers are available for Standard Drive/Idler units with Gravity Roller, MicroSpan, and Wire Mesh transfers.

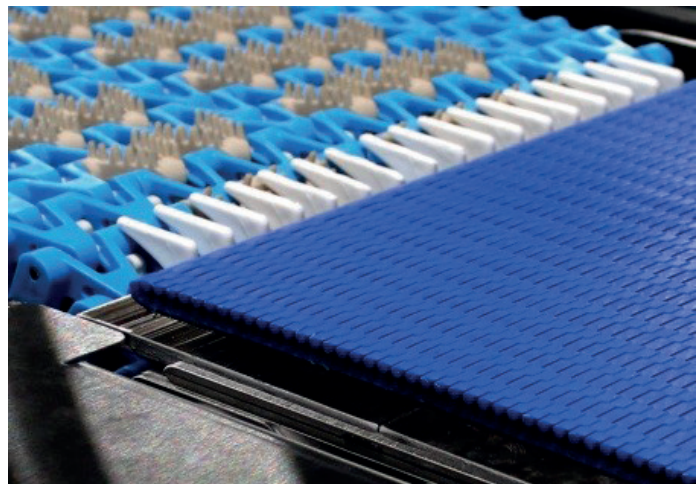

The information provided are guidelines only. This does not represent all design variations possible. For detailed or specific design requirements, please contact a representative or email info@spantechllc.com.

THANK YOU

FOLLOW US ON SOCIAL MEDIA AND KEEP UP WITH ALL OF OUR INNOVATIVE SOLUTIONS



The information provided are guidelines only. This does not represent all design variations possible. For detailed or specific design requirements, please contact a representative or email info@spantechllc.com.